

BLÅ STATION

UK PRICE LIST 2018



CONDITIONS OF SALE

PRICES

This price list supersedes all previous price lists. All prices are in EURO (€) excluding statutory value-added tax and any import duties.

TERMS OF PAYMENT

30 days net or as per written agreement. Invoices not settled by the due date will be subject to interest charged at 12%. Goods sold will remain the seller's property until paid for in full.

DELIVERY

Ex-works Åhus, Sweden, including export packaging.

COMPLAINTS

Any complaints must be made known to Blå Station within 7 days of receipt of the goods. Goods that have been delivered may not be returned without prior approval from Blå Station.

TRANSPORT DAMAGE

All goods are transported at the purchaser's risk. Transport insurance will be arranged upon written request, at which time the insurance premium will be invoiced to the purchaser. If goods are shipped using Blå Station's freight contract, the customer must verify upon reception that the shipment is correct as regards the number of packages and their condition. If the packaging is damaged or if a package is missing, this must be stated on the consignment note and Blå Station must be informed of the same in writing within 5 days. Failure to do this gives Blå Station the right to debit any extra costs that may be incurred in resolving this matter. Retailers and distributors are responsible for informing end customers of this obligation.

WARRANTY PERIOD

Blå Station guarantees materials and constructions for 3 years from the date of delivery. This guarantee does not extend to furniture upholstery or to damage or to what may be regarded as normal wear and tear. Blå Station provides a one-year warranty for customized products.

DISPATCH

4–8 weeks unless otherwise agreed.

CHANGES TO ORDERS

Blå Station is unable to accept changes to orders that are made less than 4 weeks before the specified delivery date. Customers returning any wrongly ordered items will be debited 40% of the value of the goods returned.

UPHOLSTERY

In this price list all upholstered furniture contains either CMHR foam or interliner accordingly to British standard. This is already included in the prices. Blå Station's standard fabrics are shown in our LIST OF FABRICS. In the absence of written instructions for buyer supplied fabric, Blå Station reserves the right to choose the direction of the pattern and the right side of the fabric. If an item of furniture is to be covered with a fabric other than those in Blå Station's standard collection, the fabric must first be approved by Blå Station.

OTHER INFORMATION

The price list is for our standard product range. Other designs may be offered for contract or project sales. Reference are made to colour charts in a number of places, some of which can be found at the beginning of the priceless and at www.blastation.se

We use vegetable tanned leather from Tärnsjö Tannery in certain products. *'The tiny scratches and scars on leather are the hallmarks of its natural origin and proof that the animal has enjoyed a fair measure of freedom in its lifetime.'*

– Börge Lindau

When selecting vinyl or artificial leather as the covering, small creases may appear along the seams. This applies to products with round shapes.

When purchasing products with stained or lacquered colours with set-up costs, only one set-up cost is charged per colour.

RESERVATIONS

We reserve the right to price, design and construction changes and amendments to payment terms.

INDEX | **A-Ö**

TABLETOPS	91	GATE G2	40	POCKET O66	68
ALLY S06	13	GINKGO A40	41	POCKET O66L	68
B2	14	HONKEN O141	42	POLSTERGEIST S20	69
B4	15	HONKEN O142	42	POND L841	70
B25	16	HONKEN O143	42	POND L842	70
B26	16	HONKEN S O144, O145, O146	43	POPPE O151	71
BABEL L30	17	HONKEN XL O147, O148, O149	43	POPPE O152	71
BEPLUS B+	18	HONKEN L14	44	POPPE O161	72
BIMBO O60	19	HÖVDING B8M	45	POPPE O162	72
BIMBO O61	19	HÖVDING B8L	45	PUCCA O541	73
BIT L7	20	INNOVATION C O70	46	PUCCA O542	73
BIT L6	21	ISLAND O80	47	PUCCA O543	73
BOB S80	22-23	ISLAND O82	47	PUPPA O53	74
BOO O48	24	ISLAND L80	47	QVARTO S10	75
BOO O48A	24	ISLAND L82	47	SIZE L901	76
BOO O49	25	KAFFE O11	48	SIZE L903	77
BOO O49A	25	KAFFE O12	48	SIZE L904	78
CLIP L41	26	KAFFE L11	49	SIZE L905	79
CODE 27 O27	27	KAFFE L11S	50	SPARTA B15	80
COURONNE L37	28	KOJA S51H	51	STING O30	81
DENT B501	29	KOJA S51L	51	STING O30A	81
DENT B502	29	KOJA S53H	52	STOVE O64	82
DENT B504	29	KOJA S53L	52	STRAW O35	83
DENT B502-65	30	KOJA S52H	53	STRAW O36	83
DENT B502-82	30	KOJA S52L	53	STRAW O37	83
DENT DRESSED B501D	31	KOJA ELEMENT A50	54	SUPERSTRAW S25	84
DENT DRESSED B502D	31	L1	55	SUPERKINK S26	85
DENT DRESSED B504D	31	LEVEL L32	56	SUPERKINK S27	85
DENT DRESSED B502D-65	32	LEVEL L31	57	SÖNDAG O62	86
DENT DRESSED B502D-82	32	LUCKY B17	58	UNIT S161	87
DUNDER S60	33	MIKA L28	59	UNIT S162	87
DUNDRA S70	34	MONO L88	60	UNIT L161	87
DUNDRA S70A	34	MONO L89	60	VISP A30	88
DUNDRA S70AS	34	MORRIS JR O651	61	WILMER O55	89
DUNDRA S73	35	MORRIS JR O652	61	WILMER O56	89
DUNDRA S73-65	35	OPPO O50	62	WILMER O57	89
DUNDRA S73-82	35	OPPO O50A	62	WILMER O58	89
DUNDRA S72-65	36	OPPO O52	62	WILMER O59	89
DUNDRA S72-82	36	OPPO O52A	62	ÅHUS B30	12, 90
DUNDRA S71	37	OPPOCEMENT O51L	63	ÅHUS B31	12, 90
DUNDRA S71AS	37	MINI-OPPO A15	63		
DUNDRA S74	38	PEEKABOO O43	64	IMAGE INDEX	4
DUNDRA S74A	38	PING-PONG L23	65	INDEX FURNITURE TYPES	8
GAIA A42	39	PING-PONG L23	66	FABRIC LIST	9
		PM A11	67	COLOUR CHART	10

IMAGE INDEX



IMAGE INDEX



DUNDRA | 34-38



WILMER | 89



INNOVATION C | 46

POCKET | 68



HONKEN | 42

HONKEN S, XL | 43



POPPE | 71-72



OPPO | 62

OPPOCEMENT | 63

MINI-OPPO | 63



PUPPA | 74

PUCCA | 73

PM | 67

IMAGE INDEX



ÅHUS | 12, 90

MORRIS JR | 61

ALLY | 13



POLSTERGEIST | 69



CODE 27 | 27



QVARTO | 75



UNIT | 87



DUNDER | 33



BOB | 22-23



KOJA | 51-52



ISLAND | 47

IMAGE INDEX



SIZE | 76-79



PING-PONG | 65-66



BIT | 20-21



CLIP | 26

LEVEL | 56-57



BABEL | 17

COURONNE | 28

L1 | 55



MONO | 60

POND | 70

MIKA | 59



HONKEN | 44

KAFFE | 49-50



KOJA ELEMENT | 54

GINKGO | 41

GAIA | 39

VISP | 88

INDEX | FURNITURE TYPES

CHAIRS

B4	15
BEPLUS B+	18
BOO O48, O48A	24
BOO O49, O49A	25
DENT B501	29
DENT B502	29
DENT B504	29
DENT DRESSED B501D	31
DENT DRESSED B502D	31
DENT DRESSED B504D	31
DUNDRA S70, S70A, S70AS	34
KAFFE O11	48
LUCKY B17	58
POPPE O161, O162	71
SPARTA B15	80
STING O30, O30A	81
STRAW O35	83
SUPERSTRAW S25	84

BAR STOOLS

B2	14
B4	15
DENT B502-65	30
DENT B502-82	30
DENT DRESSED B502D-65	32
DENT DRESSED B502D-82	32
DUNDRA S73-65	35
DUNDRA S73-82	35
DUNDRA S72-65	36
DUNDRA S72-82	36
STRAW O37	83

STOOLS | BENCHES | POUFFES

B2	14
B26	16
BIMBO O60	19
BIMBO O61	19
BOB S80	22-23
DUNDRA S73	35
GATE G2	40
HONKEN L14	44
ISLAND O80, O82	47

PM A11	67
POLSTERGEIST S20	69
PUCCA O541	73
PUCCA O542	73
PUCCA O543	73
PUPPA O53	74
STOVE O64	82
SÖNDAG O62	86
UNIT S161	87

EASY CHAIRS

ALLY S06	13
B25	16
BOB S80	22-23
DUNDRA S71, S71AS	37
HONKEN O141, O142, O143	42
HONKEN S O144, O145, O146	43
HÖVDING B8M, B8L	45
INNOVATION C O70	46
KOJA S51L, S51H	51
MORRIS JR O651, O652	61
OPPO O50, O50A	62
OPPO O52, O52A	62
OPPOCEMENT O51L	63
PEEKABOO O43	63
POCKET O66, O66L	68
POPPE O151, O152	71
QVARTO S10	75
STRAW O36	32
SUPERKINK S26	85
UNIT S162	87
WILMER O55	89
WILMER O56	89
WILMER O57	89
WILMER O58	89
WILMER O59	89
ÅHUS B30	12, 90
ÅHUS B30	12, 90

SOFAS

ALLY S06	13
BOB S80	22-23
CODE 27 O27	27

DUNDER S60	33
DUNDRA S74, S74A	38
HONKEN XL O147, O148, O149	43
KAFFE O12	48
KOJA S53L, S53H	52
KOJA S52L, S52H	53
POLSTERGEIST S20	69
QVARTO S10	75
SUPERKINK S27	85

TABLES

BORDSSKIVOR	91
BABEL L30	17
BIMBO O61	19
BIT L7	20
BIT L6	21
CLIP L41	26
COURONNE L37	28
HONKEN L14	44
ISLAND L80, L82	47
KAFFE L11	49
KAFFE L11S	50
L1	55
LEVEL L32	56
LEVEL L31	57
MIKA L28	59
MONO L88, L89	60
PING-PONG L23	65
PING-PONG L23	66
POND L841, L842	70
SIZE L901	76
SIZE L903	77
SIZE L904	78
SIZE L905	79
UNIT L161	87

SOUND ABSORBANTS

GAIA A42	39
GINKGO A40	41
KOJA ELEMENT A50	54

ACCESSORIES







MINI-OPPO A15	63
VISP A30	88

FABRIC LIST

XTREME

CAMIRA		Xtreme
--------	---	--------













BASIC FABRICS

CAMIRA		X2
		Blazer
		Main Line Plus
		Main Line Flax
		Rivet
		Patina
KVADRAT		Revive 2
GABRIEL		Step (TR.CS)
		Step melange (TR.CS)

FABRIC TYPE 1

CAMIRA		Synergy
		Landscape collection Synergy
		Aquarius
		Hemp
GABRIEL		Europost 2
		Gaja Classic
		Fame
KVADRAT		Remix 2
		Umami 1/2/3
		Floyd
SVENSSON		Flex
		Mingel (TR.CS)
		Step
		Soft/Mill
BOGESUND		Shimmer
		Liv (TR.CS)
		Puls (TR.CS)
		Frost (TR.CS)
		Porla (TR.CS)
VESCOM		Lani
		Gamut (Ej ljusa färger)
NEVOTEX		Rock (TR.CR)
		Blues (TR.CS)















FABRIC TYPE 2

CAMIRA		Silk
GABRIEL		Crisp
		Luna 2
		Breeze Fusion
		Fame Hybrid
		Capture
		Note
KVADRAT		Tonus 4
		Tonus Meadow
		Tonica 2
		Clara 2
		Memory (TR.CS)
SVENSSON		Brink
		Rock
		Retro
		Tableau
		Intro (TR.CS)
BOGESUND		Breeze
		Twilight (TR.CS)



*When choosing Velvet Fabric or Vinyl small wrinkles may occur along the seams of the product

VESCOM		Bowen
		Balta
		Lamu
		Wolin
		Fuga
ROMO		Ruskin
KIRKBY DESIGN		Grade
SPRADLING		Valencia (konstläder)*
		Silvertex (vinyl)*

FABRIC TYPE 3

CAMIRA		Craggan
		Craggan Flax
KVADRAT		Divina 3
		Divina Melange 2
		Divina MD
		Hero
		Steelcut 2
		Steelcut trio 2
		Hallingdal 65
		Canvas 2
		Rime
		Pro 3 (TR.CS)
		Sudden (vinyl)*
		Ledger (vinyl)*
		Fiord
		Molly 2
		Harald 3 (sammet)*
		Melange Nap
		San
		Foss
		Skye
GABRIEL		Criss Cross
SVENSSON		Rami
		Rami Plus
ALMEDAHLIS		Moor
SERGE FERRARI		Stamskin Top (konstläder)*
NEVOTEX		Riiz (sammet)*
SKAI		Palma (konstläder)*
		Parotega (konstläder)*
AMBLA		Ambla Collection (konstläder)*
ONRIO		Puxx 1 & 2 (konstläder)*

FABRIC TYPE 4

KVADRAT		Outback
		Sunniva 2
		Balder 3
		Vidar 3
		Coda 2
		Matrix
VESCOM		Silica (vinyl)*
MIKO		Dinamica-Plain (mikrofiber)
		Dinamica-Melange (mikrofiber)

 All fabrics meet fire requirements in the standard SSEN 1021-1/2 and BS 5852 ig.s 2-3 when used on flame-retardant foam with a minimum density of 35 kg/m³. Fabrics on the left marked with the flame symbol also meet BS 5852 ig.s 2-5/Crib 5 requirements.

 SIS Ecolabelling AB hereby declares that fabrics labelled with the EU-flower comply with European Ecolabel requirements for textiles.

 Parts of the collection bear the Swan and the Möbelfakta label.

COLOUR CHART

5 | LEATHER (STRAPS)



BLACK NO 9308
TÄRNSJÖ



NATURAL NO 9300
TÄRNSJÖ

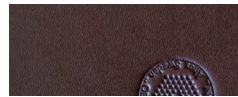

BROWN NO 9368
TÄRNSJÖ

6A | LEATHER (CUSHION)



ELMO SOFT



TÄRNSJÖ

6B | LEATHER (ELMOTIQUE)



BLACK 99001

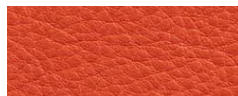

TOMATO RED 45011

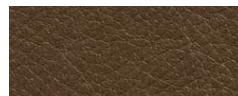

TAUPE 13033



BROWN 93718

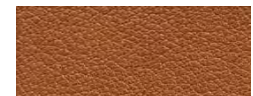

COGNAC 43807

6C | LEATHER (ELMODESIGN PIQUÉ)

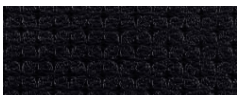

BLACK 99999



BROWN 33004

OUR FABRIC SUPPLIERS

ALMEDAHLIS	www.almedahls.se
AMBLA	www.ambla.com
BOGESUND	www.bogesunds.se
CAMIRA	www.camirafabrics.com
ELMO LÄDER	www.elmoleather.com
GABRIEL	www.gabriel.dk
KIRKBY DESIGN	www.kirkbydesign.com
KVADRAT	www.kvadrat.dk
MIKO	www.dinamicamiko.com
NEVOTEX	www.nevotex.com
ONIRO	www.onirotextiles.com
ROMO	www.romo.com
SKAI	www.skai.com
SPRADLING	www.spradling.eu
SVENSSON	www.ludvigsvensson.com
TÄRNSJÖ GARVERI	www.tarnsjogarveri.com
VESCOM	www.vescom.com

COLOUR CHARTS FOR LEATHER

NO. 5. Stiff vegetable-tanned leather from Tärnsjö Garveri.

NO. 6. Soft, vegetable tanned cushion leather from Tärnsjö Garveri and a selection from Elmo Läder's collection.

Leather charts Nos 5 and 6 may be ordered separately.

CUSTOMER-SUPPLIED FABRIC:

As per agreement; fabric must first be approved by Blå Station. The price for products with customer-supplied fabric is the same as for Xtreme. We charge a handling fee of EURO 90 per order. Fabric requirement specified by agreement applies to fabrics with solid colours. Please check fabric requirement and delivery address.

We are also able to offer fabrics that do not appear in our fabric list. Please ask. We cannot take responsibility for minor differences in the colour shades.

COLOUR CHART

1 | STEEL AND METAL



STAINLESS STEEL

CHROME PLATED STEEL
(CHROME III)

BLACK LACQUERED STEEL



GALVANIZED STEEL



ALUMINIUM

2A | PAINTED STEEL (SATIN FINISH) GLOSS 7

WHITE
RAL 9016LIGHT GREY
RAL 7037BLACK
RAL 9005GREY
RAL 7012

SILVER

2A | PAINTED STEEL (SMOOTH) GLOSS 75

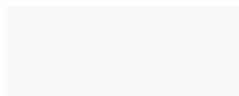
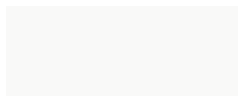
WHITE
RAL 9016WHITE
RAL 9016BLACK
RAL 9005

2B | PAINTED STEEL (SATIN FINISH) GLOSS 7

TOMATO RED
RAL D2 0404060AUBERGINE
RAL D2 0202010MIDNIGHT BLUE
RAL 5011DARK GREEN
RAL 6012TAUPE
RAL 7013

2C | ANODISED ALUMINIUM

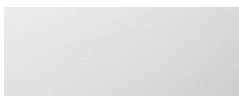

ALUMINIUM

3 | WOOD

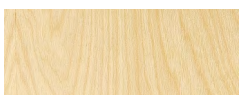

BIRCH



ASH



OAK

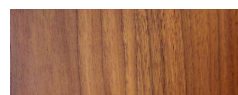

WALNUT

4 | STAINED AND LACQUERED WOOD

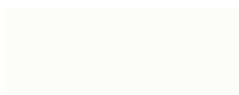
WHITE
NCS S0500-NLIGHT GREY
NCS S3500-NDARK GREY
NCS S7500-N

BLACK

YELLOW
NCS S2050-Y10RORANGE
NCS S2070-Y70RPINK
NCS S1515-Y80RRED
NCS S3560-Y80RGREEN
NCS S6010-G30YBLUE
NCS S7020-R80BLIGHT PETROLEUM
NCS S4010-B70G



B30 15.7 kg | 0.9 m³/pc (1.7 m³/2 pcs)

B31 15.1 kg | 0.9 m³/pc (1.7 m³/2 pcs)

EASY CHAIR with armrests. Steel frame. Moulded CMHR polyurethane foam padding. Upholstered in fabric or leather. Leather as per cc. 6a. Frame in painted steel. B30 has table-top and B31 has no table-top. Table-top in lacquered or oiled oak or stone slab.

Fabric	Xtreme	Basic	1	2	3	4	Leather
B30 Black Clear lacquered or oiled oak	1 431	1 477	1 525	1 569	1 616	1 681	2 022
B30 Black Clear lacquered ash	1 431	1 477	1 525	1 569	1 616	1 681	2 022
B30 Black White Carrara marble	1 598	1 644	1 694	1 736	1 783	1 848	2 189
B30 Black Green Guatemala marble	1 598	1 644	1 694	1 736	1 783	1 848	2 189
B30 Black Black Marquina marble	1 598	1 644	1 694	1 736	1 783	1 848	2 189
B31 Black Without table	1 431	1 477	1 525	1 569	1 616	1 681	2 022

Surcharge, net (+)

Setup charge for frames in other colours as per cc. 2b. NET/colour	220
Setup charge for frame in custom RAL colour. NET/colour	650

Other finishes available for projects.

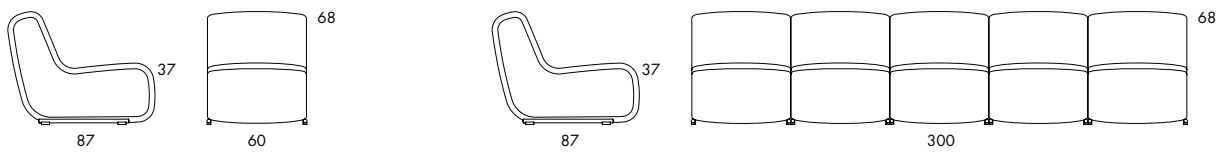

S06 17.3 kg | 0.45 m³/pc (1.4 m³/4 pcs)

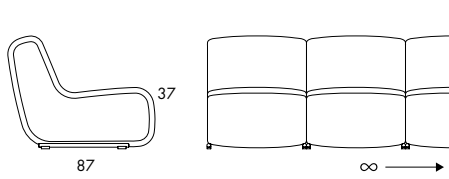

EASY-CHAIR | SECTIONAL SOFA. Wood and steel frame. Padding in CMHR moulded polyurethane foam. Fabric upholstery. Stainless steel frame with integral magnet for linking sections.

We recommend Ally in two colours with different colours on the seats and sides. Chose fabrics from the same fabric type, or the higher-priced fabric determines the price of the section.

Fabric	Xtreme	Basic	1	2	3	4
S06 Stainless steel Magnetic linking	1 679	1 751	1 807	1 865	1 918	1 996

*When selecting vinyl only Skai Parotega or Spradling Valencia is suitable

Börge Lindau 1986

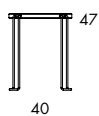
B2

B2-47 4.0 kg | 0.24 m³/4 pcs 

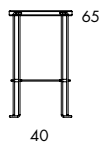

B2-65 6.3 kg | 0.24 m³/pc

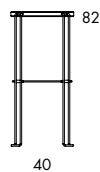

B2-82 7.1 kg | 0.24 m³/pc

STOOL | BARSTOOL. Seat in compression moulded, layer-glued, clear-lacquered or stained birch veneer. Steel frame. Plastic foot. Stackable in height 47 cm.

B2-47 Black steel | Clear-lacquered birch **322**

B2-47 Black steel | Black birch **322**

B2-47 Stainless steel | Clear-lacquered birch **480**

B2-47 Stainless steel | Black birch **480**

B2-65 Black steel | Clear-lacquered birch **436**

B2-65 Black steel | Black birch **436**

B2-65 Stainless steel | Clear-lacquered birch **680**

B2-65 Stainless steel | Black birch **680**

B2-82 Black steel | Clear-lacquered birch **444**

B2-82 Black steel | Black birch **444**

B2-82 Stainless steel | Clear-lacquered birch **705**



B2-82 Stainless steel | Black birch **705**

Surcharge (+)

Seat centre stained as per cc. 4 **31**

Full seat stained as per cc. 4 **39**

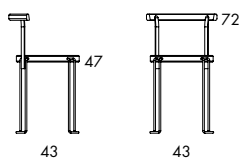
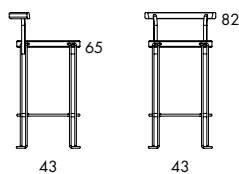
Seat centre leather covered as per cc. 5 **70**

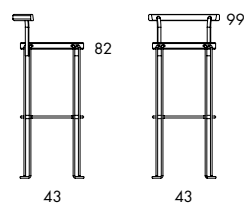
**B4-47** 4.8 kg | 0.24 m³/4 pcs **B4-65** 7.1 kg | 0.24 m³/pc**B4-82** 7.9 kg | 0.26 m³/pc

CHAIR | BAR CHAIR. Seat and back in compression moulded, layer-glued clear-lacquered or stained birch veneer. Steel frame. Plastic foot. Stackable in height 47 cm.

B4-47 Black steel Clear-lacquered birch	480
B4-47 Black steel Black birch	480
B4-47 Stainless steel Clear-lacquered birch	695
B4-47 Stainless steel Black birch	695

B4-65 Black steel Clear-lacquered birch	591
B4-65 Black steel Black birch	591
B4-65 Stainless steel Clear-lacquered birch	869
B4-65 Stainless steel x Black birch	869

B4-82 Black steel Clear-lacquered birch	619
B4-82 Black steel Black birch	619
B4-82 Stainless steel Clear-lacquered birch	903
B4-82 Stainless steel Black birch	903

Surcharge (+)

Seat centre stained as per cc. 4	31
Seat/back stained as per cc. 4	51
Seat centre leather covered as per cc. 5	70

Cate & Nelson 2011

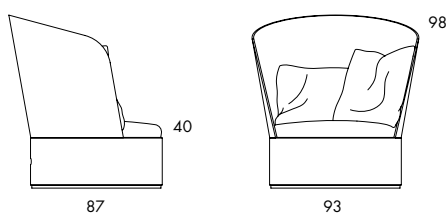
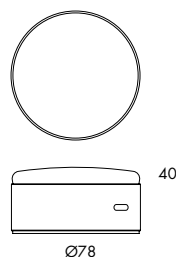
B25 & B26**B25** 27.0 kg | 1.45 m³/pc**B26** 19.5 kg | 0.45 m³/pc

EASY CHAIR | FOOTSTOOL. Frame in compression moulded veneer; stain finish or clear-lacquered ash veneer. No-sag springs. B25 has a back covered in wool felt or leather as per cc. 5. Seat/back cushions in down or polyester mix. Removable covering in fabric or leather as per cc. 6a on seat and back cushions.

Easy chair price refers to seat and back cushions in the same fabric and shade. If different colours or fabrics from the same price category are preferred, see below for surcharges. If seat and back fabrics are chosen from different fabric categories, the highest price category for the easy chair applies; or request offer. Interliner included.

Fabric	Xtreme	Basic	1	2	3	4	Leather
B25 Clear-lacquered ash Black, sand or mottled grey back	3 404	3 494	3 561	3 635	3 710	3 813	4 204
B25 Black ash Black, sand or mottled grey back	3 404	3 494	3 561	3 635	3 710	3 813	4 204
B25 White ash Black, sand or mottled grey back	3 404	3 494	3 561	3 635	3 710	3 813	4 204
<hr/>							
B25 Clear-lacquered ash Leather back as per cc. 5	5 249	5 338	5 405	5 482	5 554	5 657	6 047
B25 Black ash Leather back as per cc. 5	5 249	5 338	5 405	5 482	5 554	5 657	6 047
B25 White ash Leather back as per cc. 5	5 249	5 338	5 405	5 482	5 554	5 657	6 047
<hr/>							
B26 Clear-lacquered ash	1 991	2 033	2 074	2 107	2 142	2 186	2 619
B26 Black ash	1 991	2 033	2 074	2 107	2 142	2 186	2 619
B26 White ash	1 991	2 033	2 074	2 107	2 142	2 186	2 619

Surcharge (+)

Seat/Back cushions, 2 different colours/fabrics from same fabric cat.	63
Seat/Back cushions, 3 different colours/fabrics from same fabric cat.	125
Frame stained as per cc. 4* Min. 6 pcs/colour	39
Frame stained in custom NCS colour** Min. 8 pcs/colour	47

Surcharge, net (+)

*Set-up charge for stain as per cc. 4. NET/colour	100
**Set-up charge for stain in custom NCS colour. NET/colour	220

Other finishes, e.g. different colour wool felt, available for projects.

Fredrik Mattson 2008

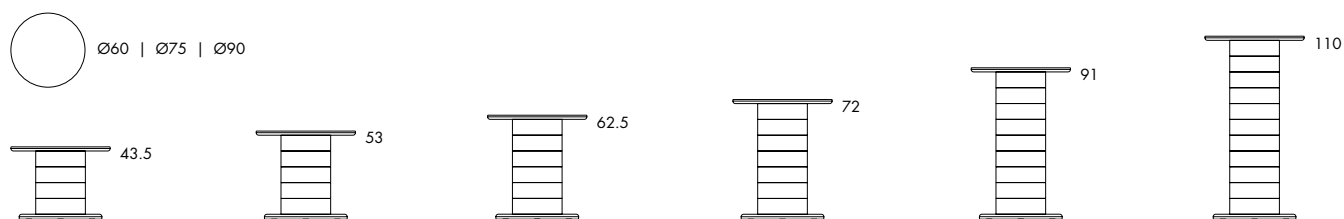
L30 | **BABEL****L30** 17.7 kg**L30** 29.2 kg

PEDESTAL TABLE. Built up using compression moulded, layer-glued lacquered birch rings finished in all white. White-painted MDF tabletop. Footplate Ø55 with black lacquered cover. Each ring adds 9.5 cm. Table top thickness 25 mm.

Tabletop (cm)	Ø60	Ø75	Ø90
L30 Black foot White Height 43.5 cm 4 rings	798	836	858
L30 Black foot White Height 53 cm 5 rings	872	909	930
L30 Black foot White Height 62.5 cm 6 rings	947	983	1 005
L30 Black foot White Height 72 cm 7 rings	1 019	1 058	1 078
L30 Black foot White Height 91 cm 9 rings	1 169	1 208	1 225
L30 Black foot White Height 110 cm 11 rings	1 317	1 355	1 373

Other versions and colours available for projects.

Börge Lindau 1987

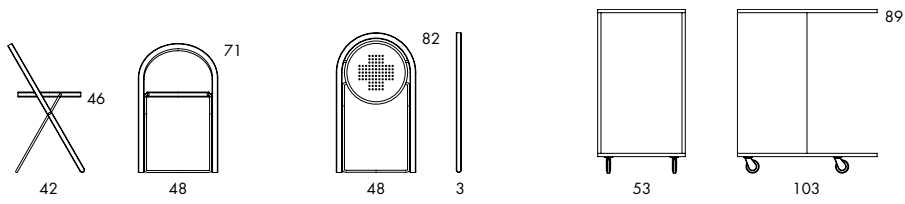
B+ | **BEPLUS****B+** 3.8 kg | 0.08 m³/4 pcs**D3**

FOLDING CHAIR. Back & seat ring in compression moulded, layer-glued, clear-lacquered birch. Steel leg frame. Plastic foot.

B+ Black steel Clear-lacquered birch	375
--	------------

B+ Black steel Clear-lacquered birch Seat center stained black	375
--	------------

Accessories

D1 Wall hook Black steel for 2 pcs B+	23
---	-----------

D3 Trolley Clear-lacquered birch for 24 pcs B+ lying flat	853
---	------------

Peter Brandt 1994/2008

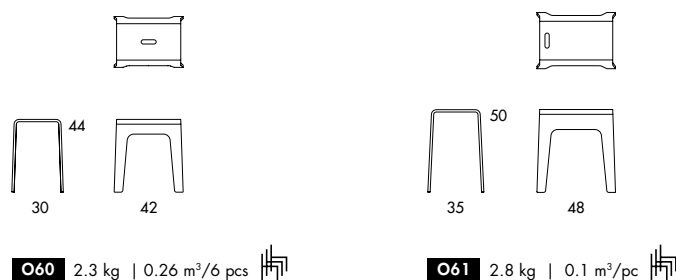
O60, O61 | **BIMBO**

STACKABLE STOOL | TABLE. Compression moulded, layer-glued lacquered birch. Finish in clear-lacquered birch or oak. O60 stain colours are applied to birch veneer. Black stain on O61 is applied to oak veneer. Plastic foot.

Wooden stool	Birch	Black	White	Cc. 4	Oak
O60 Stool	239	250	250	275	302
O61 Stool/Bedside table/Table	263	270			334

Surcharge (+)

D81 Plastic feet with replaceable wear surface	16
Stained birch in custom NCS colour** Min. 8 pcs/colour	23

Surcharge, net (+)

*Set-up charge for stain in custom NCS colour NET/colour	220
--	-----

Börge Lindau 1992

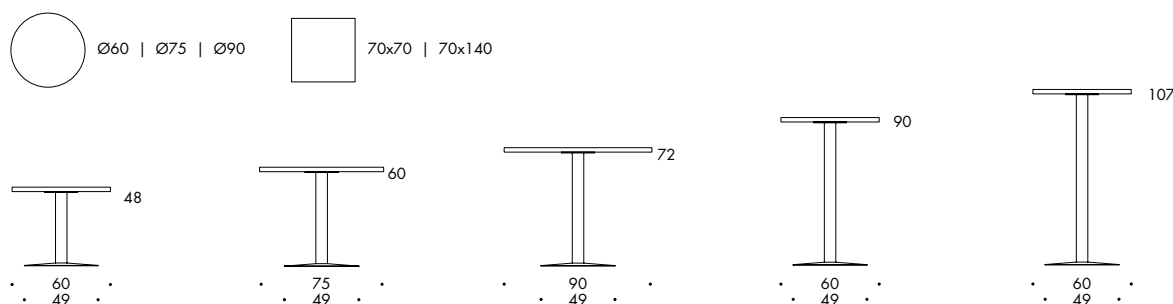
L7 | **BIT**

L7 13.9–19.7 kg | 0.05–0.09 m²/pc

TABLE. Chrome-plated (chrome III) or black-painted steel pedestal. Table-top in white compact laminate, thickness 12 mm. Available in five table heights. Footplate Ø49. Size 70x140 has two frames.

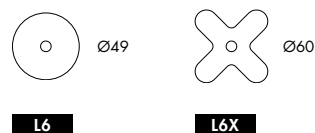

Table (cm) Height 48 cm	Ø60	Ø75	Ø90	70x70	70x140
L7 Chrome White compact laminate	669	714	797	705	1 295
L7 Black steel White compact laminate	669	714	797	705	1 295

Table (cm) Height 60 cm	Ø60	Ø75	Ø90	70x70	70x140
L7 Chrome White compact laminate	669	714	797	705	1 295
L7 Black steel White compact laminate	669	714	797	705	1 295

Table (cm) Height 72 cm	Ø60	Ø75	Ø90	70x70	70x140
L7 Chrome White compact laminate	669	714	797	705	1 295
L7 Black steel White compact laminate	669	714	797	705	1 295

Table (cm) Height 90 cm	Ø60	Ø75	70x140
L7 Chrome White compact laminate	680	722	1 319
L7 Black steel White compact laminate	680	722	1 319

Table (cm) Height 107 cm	Ø60	Ø75	70x140
L7 Chrome White compact laminate	697	750	1 352
L7 Black steel White compact laminate	697	750	1 352

Surcharge (+)

L6X Plus base Ø60 (cm)	131
Galvanised frame for outdoor use	50
Galvanised, painted frame for outdoor use	66

Surcharge, net (+)

Setup charge as per cc. 2a fine textured finish	220
*Setup charge for steel in custom RAL colour	650

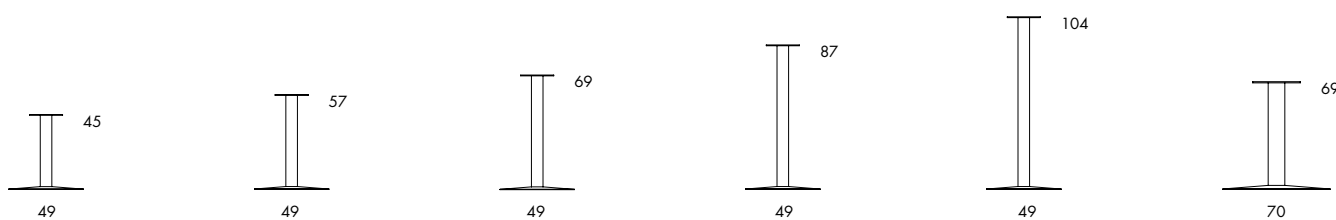

L6 8.8–11.2 kg | 0.04–0.05 m³/pc

L6B

PEDESTAL FOR TABLE. Chrome-plated (chrome III) or black-painted pedestal and steel footplate. Bit Pedestal L6 has a round footplate, Ø49. Bit Pedestal L6X has a Ø60 plus base and L6Y has a Ø65 propeller base. Bit Pedestal L6B is larger and is used for large tabletops.

Table base, height (cm)	45	57	69	87	104
L6 Chrome Footplate Ø49 cm Column Ø7 cm	339	339	339	345	367
L6X Chrome Plus base Ø60 cm Column Ø7 cm	480	480	480	486	505
L6Y Chrome Propeller base Ø60 cm Column Ø7 cm	480	480	480	486	505
L6 Black Footplate Ø49 cm Column Ø7 cm	339	339	339	345	367
L6X Black Plus base Ø60 cm Column Ø7 cm	480	480	480	486	505
L6Y Black Propeller base Ø60 cm Column Ø7 cm			480		
L6B Chrome Footplate Ø70 cm Column Ø10.8 cm					948
L6B Black Footplate Ø70 cm Column Ø10.8 cm					948

Surcharge (+)

Galvanised frame for outdoor use	47
Galvanised + black painted frame for outdoor use	63
Footplate for L6 Ø60 cm	94

Surcharge, net (+)

Set-up charge as per cc. 2a fine textured finish	220
*Set-up charge for steel in custom RAL colour	650

Recommended max sizes for tabletops

Footplate Ø49 (cm)

L6 Base height 45, 57, 69 cm	Ø90	70x70
L6 Base height 87, 104 cm	Ø70	60x60

Plus base Ø60 (cm)

L6X Base height 45, 57, 69 cm	Ø110	80x80
L6X Base height 87, 104 cm	Ø90	70x70

Footplate Ø70 (cm)

L6B Base height 69 cm	Ø140	90x90
-----------------------	------	-------

Standard tabletops; see price list on last page.

Other finishes available for projects.

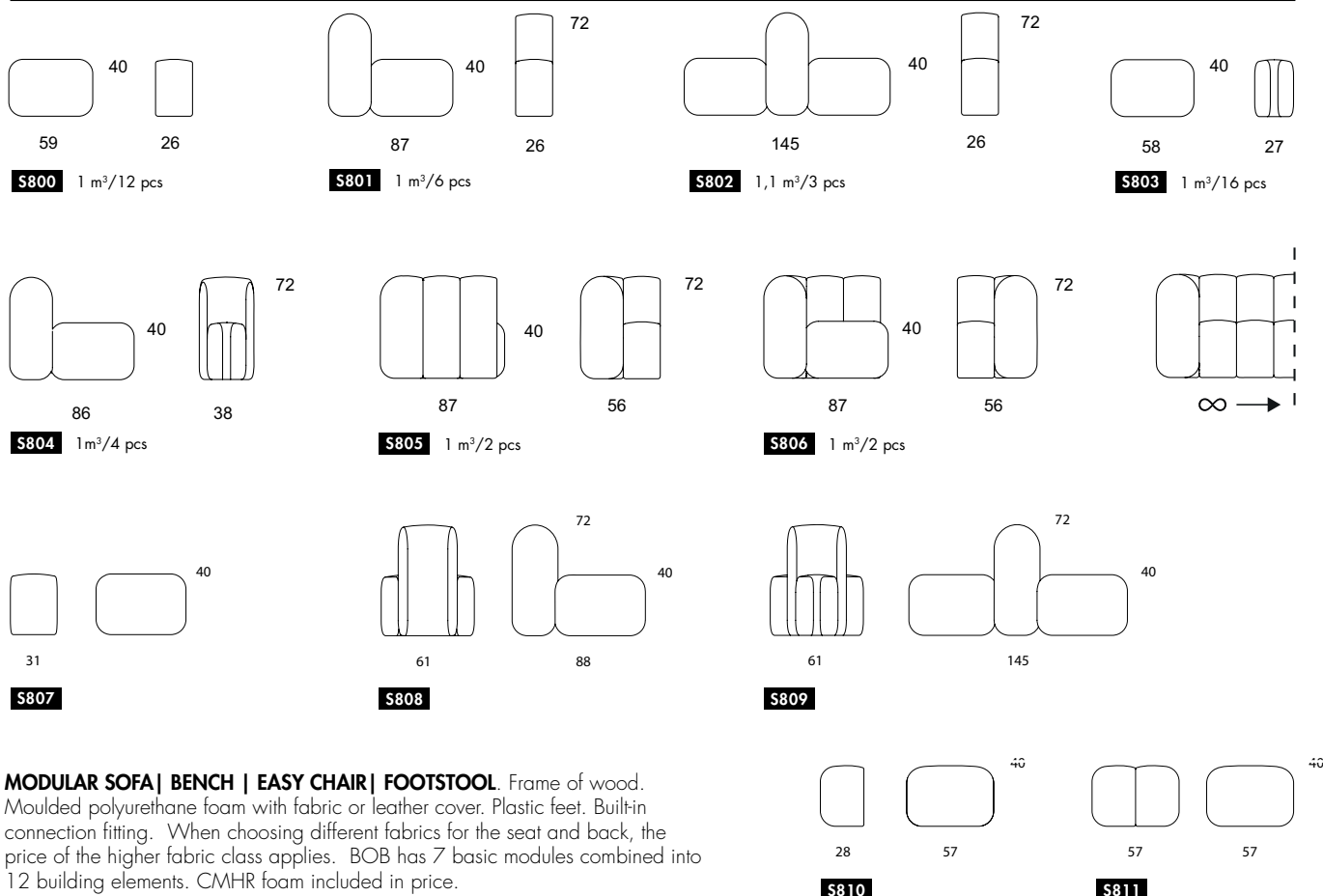

MODULAR SOFA | BENCH | EASY CHAIR | FOOTSTOOL. Frame of wood. Moulded polyurethane foam with fabric or leather cover. Plastic feet. Built-in connection fitting. When choosing different fabrics for the seat and back, the price of the higher fabric class applies. BOB has 7 basic modules combined into 12 building elements. CMHR foam included in price.

BOB can be put together in endless combinations; straight, curved and with seats on both sides of the backrest. The above shows just a couple of examples. Use CAD files or our BOB Planner available on our website to create your desired variant and attach the illustration from the BOB planner in the order. Follow the link to BOB planner here.

Fabric	Mainline Flax	Basic	1	2	3	4	Leather
S800 Straight seat	252	273	292	314	333	368	468
S803 Inner curved seat	277	298	317	341	360	396	476
S801 Straight seat + Back	539	572	612	658	696	767	997
S804 Curved seat + Back	618	651	691	740	778	853	1 068
S802 Straight seat + Back + Straight seat	795	845	889	957	1 014	1 121	1 450
S805 Arm rest end piece, Right	1 430	1 544	1 669	1 819	1 938	2 167	2 528
S806 Arm rest end piece, Left	1 430	1 544	1 669	1 819	1 938	2 167	2 528
S807 Outer curve seat	280	291	323	352	378	419	589
S808 2x Outer curve seat + Back	817	836	906	969	1 027	1 114	1 616
S809 2x Outer curve seat + Back + Inner curve seat	1 078	1 109	1 197	1 277	1 350	1 459	2 047
S810 Half moon seat	277	284	313	338	361	397	563
S811 2x Half moon seat	553	569	625	675	722	794	1 125

Examples

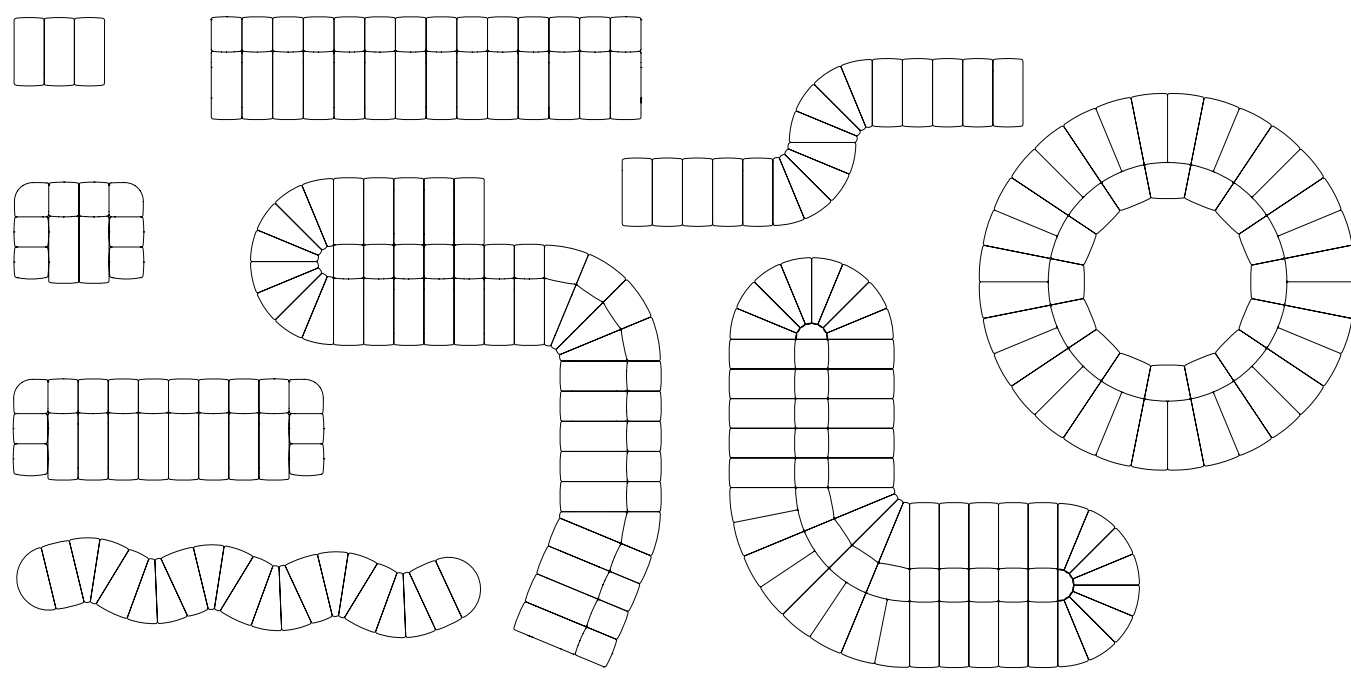
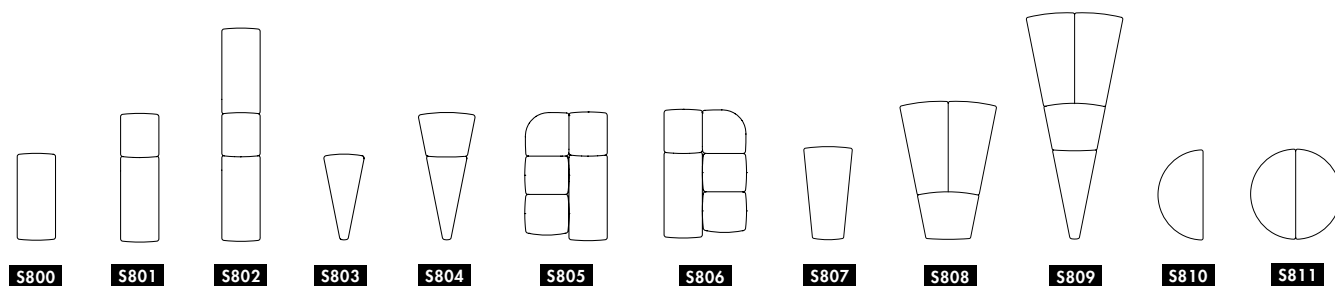

2-seat sofa without armrest end pieces (5xS801)	2 694	2 860	3 059	3 289	3 479	3 836	4 985
4-seat sofa without armrest end pieces (9xS801)	4 849	5 149	5 505	5 919	6 262	6 904	8 974
Easy chair with armrests (1xS805 + 1xS806)	2 859	3 088	3 338	3 638	3 875	4 334	5 056
3-seat sofa with arm rest end pieces (1xS805 + 1xS806 + 5xS801)	5 553	5 948	6 396	6 926	7 354	8 170	10 042



Accessories	Mainline Flax	Basic	1	2	3	4	Leather
D800S Airport ending Padded with polyurethane foam , half circle	227	242	258	273	289	305	320
D810S Circle center Padded with polyurethane foam , circle							
D800 Airport ending Table in oak or ash, half circle	289						
D810 Circle center Table in oak or ash, circle	352						
Electrical outlets (extension cord included, 2meters)	160						
USBx2 (extension cord - wieland-schuko not included)	188						
Extension cord - wieland-schuko 1,5m	55						

Recommended fabrics	Basic	1	2	3	4	Leather
	Blazer	Aquarius	Tonica	All Divina	Sunniva	Elmotique
	Mainline Plus	Hemp	Brink	Steelcut	Balder	Elmo Soft
	Gaja Classic		Silk	Steelcut Trio		
	Fame	Breeze Fusion		Hallingdal		
	Soft/Mill	Fame Hybrid		Canvas		
	Synergy	Valencia*		Rime		
	Step	Breeze		Rami/ RamiPlus		
				Capture	Moor	
				Ruskin	Fiord	
					Harald	

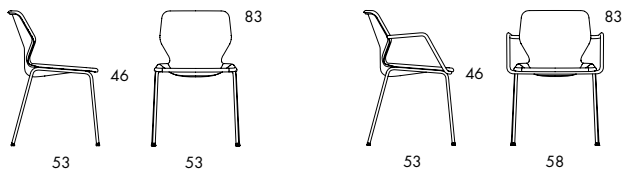
Stefan Borselius 2008

O48, O48A | **BOO****O48** 4.1 kg | 0.29 m³/pc **O48A** 5.45 kg | 0.36 m³/2 pcs 

STACKABLE CHAIR | ARMCHAIR. Seat shell in 100% hot-moulded polyester form felt. The inside of the form felt shell can be laminated with microfibre Plain, Melange/Dinamica, Waterborn/Kvadrat or leather as per colour chart. Óa. Frame in chrome-plated (chrome III) or black-painted steel. With or without arms. Flexible feet in acetal plastic.

O48 Chrome Anthracite, grey, light grey form felt	394
O48 Chrome Anthracite, grey, light grey form felt Inside Dinamica	581
O48 Chrome Anthracite, grey, light grey form felt Inside Waterborn	616
O48 Chrome Anthracite, grey, light grey form felt Inside black leather	664
<hr/>	
O48 Black steel Anthracite, grey, light grey form felt	413
O48 Black steel Anthracite, grey, light grey form felt Inside Dinamica	597
O48 Black steel Anthracite, grey, light grey form felt Inside Waterborn	633
O48 Black steel Anthracite, grey, light grey form felt Inside black leather	683
<hr/>	
O48A Chrome Anthracite, grey, light grey form felt	473
O48A Chrome Anthracite, grey, light grey form felt Inside Dinamica	656
O48A Chrome Anthracite, grey, light grey form felt Inside Waterborn	695
O48A Chrome Anthracite, grey, light grey form felt Inside black leather	742
<hr/>	
O48A Black steel Anthracite, grey, light grey form felt	489
O48A Black steel Anthracite, grey, light grey form felt Inside Dinamica	673
O48A Black steel Anthracite, grey, light grey form felt Inside Waterborn	711
O48A Black steel Anthracite, grey, light grey form felt Inside black leather	761

Accessories

D48 Chrome Trolley for up to 25 chairs	483
--	------------

Surcharge (+)

Felt-covered plastic feet or glides for various surfaces. Price/chair	6
Double-laminated form felt (inside & out) in Dinamica	125

Stefan Borselius 2008

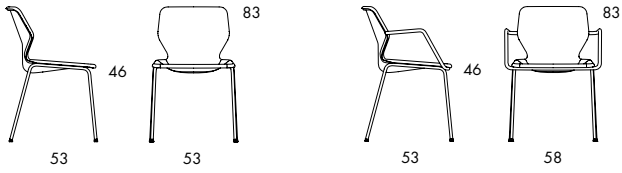
O49, O49A | **BOO VACUUM**

O49 4.65 kg | 0.29 m³/pc 

O49A 4.95 kg | 0.36 m³/2 pcs 

STACKABLE CHAIR | ARMCHAIR. Seat shell in vacuum-formed ABS-plastic. Chrome-plated steel frame (chrome III). With or without arms. Flexible feet in acetal plastic.

O49 Chrome | Black matte ABS plastic **297**

O49 Chrome | White gloss ABS plastic **314**

O49A Chrome | Black matte ABS plastic **375**

O49A Chrome | White gloss ABS plastic **391**

Accessories

D48 Black | Trolley for up to 25 chairs **483**

Jonas Forsman 2005

L41 | **CLIP**

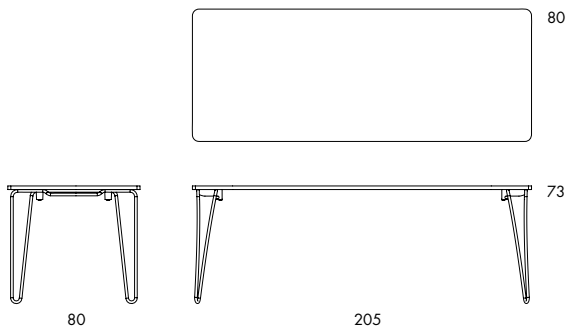

L41 26 kg | 0.4-0.6 m³/pc

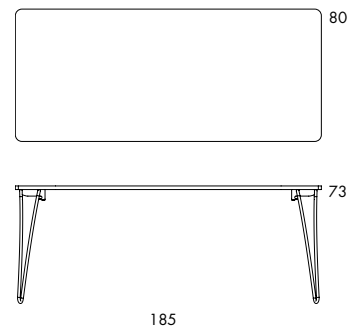

L41 24 kg | 0.4-0.6 m³/pc

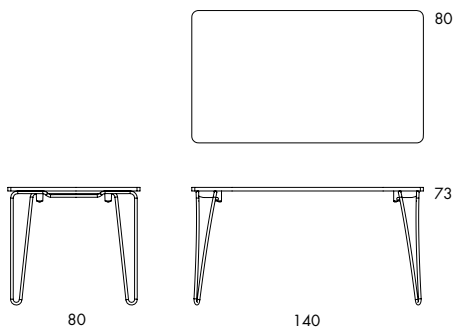
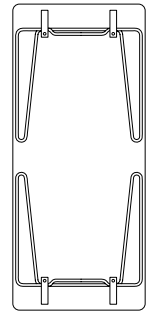

L41 20 kg | 0.4-0.6 m³/pc

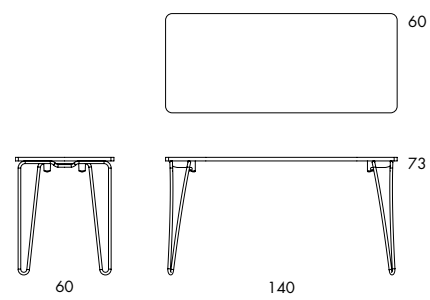

L41 17 kg | 0.4-0.6 m³/pc

FOLD-DOWN TABLE. Chrome-plated steel legs (chrome III). Fittings in ABS plastic. Lightweight Eurolight tabletop in 3.8 cm white melamine with white edging. The table is 10.5 cm thick when folded down. Plastic foot.

Table (cm)	205x80	185x80	140x80	140x60
L41 Chrome White melamine	1 142	1 131	1 042	998

Surcharge (+)

D41 Chrome Trolley for 10 pcs tables lying flat	1 328
---	-------

Other tabletop and table base versions available for projects.

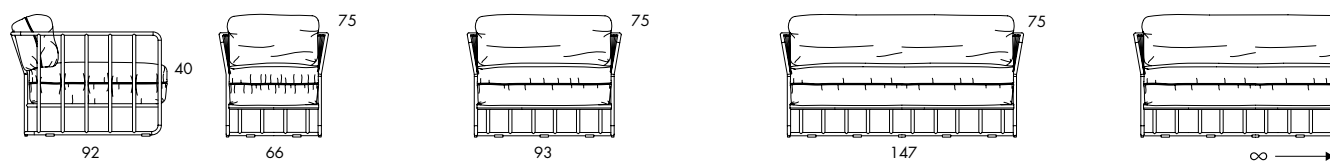
**O27A** 22.4 kg | 0.91 m³/pc**O27B** 30.5 kg | 1,06 m³/pc**O27C** 45 kg | 1.92 m³/pc

EASY CHAIR | SOFA WITH REVERSIBLE CUSHIONS. The sofa can be made in any length in increments of 27 cm. Black, matte finish steel frame. The seat and back cushions are padded with a mixture of down and feathers around a polyester core. Cushion padding is identical on both sides and reversible. Therefore choose two shades from the same fabric category to enjoy more visual combinations. Artificial leather, microfibre and vinyl may only be used on one side of a cushion; choose textile for the other. Side cushions are optional. Interliner included.

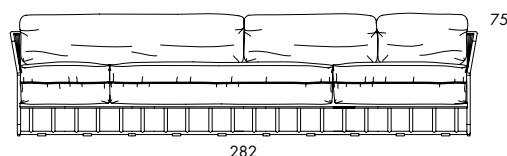
**O27ABC**

	Alt.	Length	Fabric	Xtreme	Basic	1	2	3	4
O27-A		66 cm		2 227	2 297	2 344	2 398	2 461	2 525
O27-B		93 cm		2 683	2 778	2 838	2 913	2 994	3 078
O27-AA		120 cm		3 517	3 663	3 750	3 864	3 986	4 114
O27-C		147 cm		3 595	3 738	3 897	4 041	4 175	4 373
O27-BB		174 cm		4 322	4 514	4 633	4 781	4 945	5 113
O27-AC		201 cm		4 822	5 031	5 261	5 466	5 658	5 941
O27-BC	ABB	228 cm		5 258	5 486	5 738	5 964	6 173	6 483
O27-BBB		255 cm		5 910	6 199	6 538	6 718	6 965	7 238
O27-ABC	CC	282 cm		6 152	6 574	6 948	7 141	7 287	7 683
O27-BBC		309 cm		6 646	6 926	7 173	7 455	7 649	8 091
O27-BBBB		336 cm		7 630	7 950	8 314	8 643	8 947	9 252
O27-BCC	ABCC	363 cm		7 733	7 874	8 221	8 546	8 905	9 296
O27-AACC		390 cm		8 319	8 680	8 993	9 343	9 747	10 303
O27-ABCC	CCC	417 cm		8 750	9 135	9 566	9 952	10 313	10 766
O27-BBCC		444 cm		8 852	9 241	9 680	10 075	10 444	10 846
O27-ACCC	AABCC	471 cm		9 546	9 964	10 441	10 864	11 264	11 852
O27-ABBCC	BCCC	498 cm		10 423	10 886	11 408	11 877	12 314	12 959
O27-BBBCC		525 cm		10 777	11 256	11 800	12 289	12 745	13 256
O27-ABCABC	CCCC	552 cm		11 556	12 078	12 668	13 037	13 695	14 262
O27-ABBBCC	BBBBBB	579 cm		11 992	12 533	12 984	13 697	14 209	14 806
O27-AABCCC	AAABCC	606 cm		12 450	13 011	13 647	14 215	14 587	15 373

Accessories

D29 Side cushion (armrest)	163	177	184	194	206	219
----------------------------	-----	-----	-----	-----	-----	-----

Surcharge, net (+)

*Set-up charge for steel frame painted as per cc. 2b. NET/colour	430
*Set-up charge for steel frame in custom RAL colour. NET/colour	650

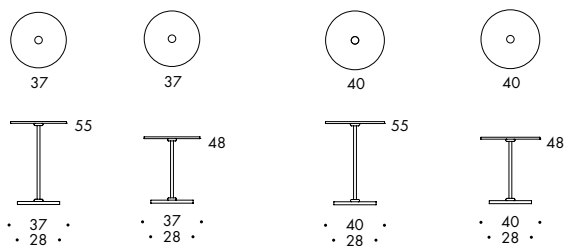



L37 12.9 kg | 0.11 m³

SIDE TABLE. Foot, pillar and fittings in lacquered steel as per cc. 2a, smooth matte finish. Table top in mineral composite. Thickness 12mm. Alternative table top in solid wood, clear-lacquered or oiled finish. Footplate Ø28.

Tabletop (cm) Height 48 cm	Ø37	Ø40
L3748 Black Black pepper	611	
L3748 Black Moussy Pepper	611	
L3748 Black White pepper	611	
L3748 Black Golden pepper	611	
L3748 Black Ash		722
L3748 Black Oak		722
L3748 Black Walnut		788

Tabletop (cm) Height 55 cm	Ø37	Ø40
L3755 Black Black pepper	611	
L3755 Black Moussy Pepper	611	
L3755 Black White pepper	611	
L3755 Black Golden pepper	611	
L3755 Black Ash		722
L3755 Black Oak		722
L3755 Black Walnut		788

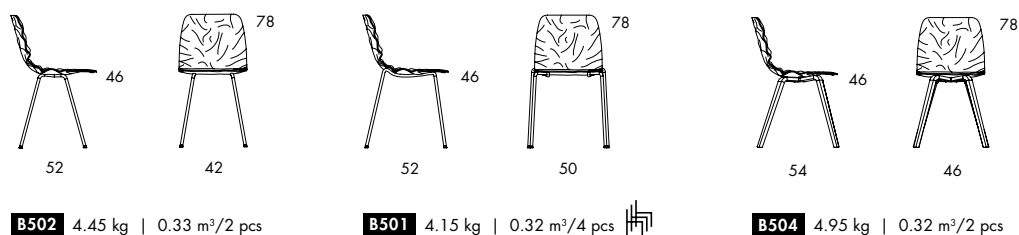
o4i 2013, 2014

B502, B501, B504 | **DENT****B502** 4.45 kg | 0.33 m³/2 pcs**B501** 4.15 kg | 0.32 m³/4 pcs **B504** 4.95 kg | 0.32 m³/2 pcs

CHAIR. Seat shell in painted, compression moulded, layer-glued wood veneer. Chrome plated (chrome III) or black-painted steel frame. Alternative frame in painted compression-moulded wood veneer. Plastic foot. Paint finishes are applied to ash veneer.

Dent is also available as Dent Dressed with an fabric or leather-upholstered seat shell. Dent B502 is also available as a barstool, height 65 cm and 82 cm.

Wooden seat shell	Ash	Black	White	Cc. 4	Oak	Walnut
B502 Chrome	367	383	383	408	367	391
B502 Black steel	383	400	400	423	383	409
B501 Chrome Stackable frame	375	391	391	427	375	400
B501 Black steel Stackable frame	391	409	409	442	391	419
B504 Fully painted ash Wooden frame	488	514	514	539		
B504 Clear-lacquered oak Wooden frame					488	

Accessories

D50 Trolley for up to 25 chairs B501	516
--------------------------------------	-----

Surcharge (+)

Felt-covered plastic feet or glides for various surfaces. Price/chair	6
Wooden frame and/or seat shell in custom NCS colour*	31
Steel frame finished in custom RAL colour* or frame finished in custom RAL colour**	23

Surcharge, net (+)

Set-up charge for steel as per cc. 2a or cc. 2b. NET/colour	220
*Set-up charge in custom NCS colour. NET/colour	220
**Set-up charge for steel in custom RAL colour. NET/colour	650

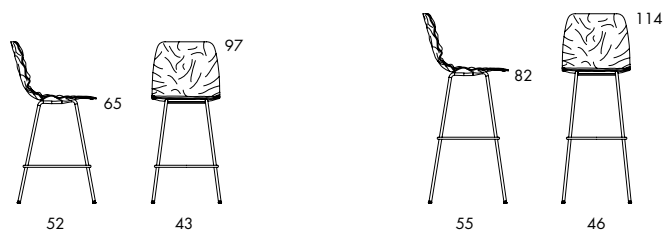
**B502-65** 6 kg | 0.36 m³/pc**B502-82** 6.45 kg | 0.44 m³/pc

BAR CHAIR. Seat shell in painted, compression moulded, layer-glued wood veneer. Chrome plated (chrome III) or black-painted steel frame. Plastic foot. Paint finishes are applied to ash veneer.

B502 is also available as an ordinary chair. Dent barstool is also available as Dent Dressed barstool with an fabric or leather-upholstered seat shell.

Wooden seat shell	Ash	Black	White	Cc. 4	Oak	Walnut
B502-65 Chrome	480	495	495	531	480	505
B502-65 Black steel	495	514	514	547	495	522
B502-82 Chrome	480	495	495	531	480	505
B502-82 Black steel	495	514	514	547	495	522

Surcharge (+)

Felt-covered plastic feet or glides for various surfaces. Price/chair	6
Seat shell finished in custom NCS colour*	33
Steel frame finished in custom RAL colour**	25

Surcharge, net (+)

Set-up charge for steel as per cc. 2a or cc. 2b. NET/colour	220
*Set-up charge for custom NCS colour NET/colouret-up charge for wood in custom NCS colour. NET/colour	220
**Set-up charge for steel in custom RAL colour NET/colouret-up charge for wood in custom RAL colour. NET/colour	650

o4i 2013, 2014

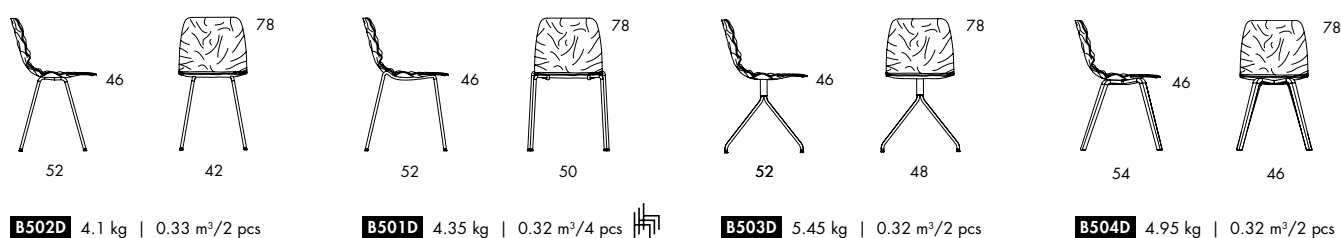
B502D, B501D, B504D | **DENT DRESSED**

PADDED CHAIR. Seat shell upholstered in fabric or leather, compression moulded wood veneer frame and O60H polyurethane padding (fire resistance standard CAL 117 A&D). Chrome plated (chrome III) or black-painted steel frame. Alternative frame in painted compression-moulded wood veneer. Plastic foot. Refer to the list below for suitable fabrics for Dent Dressed. Please consult us for other fabric selections.

B502D is also available at barstool height. Dent Dressed is also available as Dent with a wooden seat shell.

Fabric	Basic	1	2	3	4	Leather
B502D Chrome	417	427	439	450	464	609
B502D Black steel	433	444	455	467	483	627
B501D Chrome Stackable frame	425	436	447	459	475	619
B501D Black steel Stackable frame	442	452	464	478	491	634
B504D Clear-lacquered ash Wooden frame	538	548	559	572	588	731
B504D Black-painted ash Wooden frame	564	575	588	598	613	758
B504D White-painted ash Wooden frame	564	575	588	598	613	758
B504D Clear-lacquered oak Wooden frame	538	548	559	572	588	731

Accessories

D50 Trolley for up to 25 chairs B501D	516
---------------------------------------	-----

Surcharge (+)

Felt-covered plastic feet or glides for various surfaces. Price/chair	6
Wooden frame for B504D in custom NCS colour* as per cc. 4	31
Steel frame for B501D, B502D in custom RAL colour**	23

Surcharge, net (+)

Set-up charge for steel as per cc. 2a or cc. 2b. NET/colour	220
*Set-up charge for wood in custom NCS colour. NET/colour	220
**Set-up charge for steel in custom RAL colour NET/colour	650

Recommended fabrics

Basic	1	2	3	4	Leather
Xtreme	Flame	Brink	Canvas		Elmotique
X2	Step				

o4i 2015

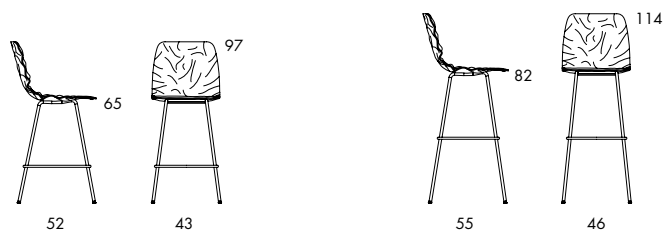
B502D-65, B502D-82 | **DENT DRESSED****B502D-65** 6.4 kg | 0.36 m³/pc**B502D-82** 6.85 kg | 0.44 m³/pc

PADDED BARSTOOL. Seat shell upholstered in fabric or leather, compression moulded wood veneer frame and O60H polyurethane padding (fire resistance standard CAL 117 A&D). Chrome plated (chrome III) or black-painted steel frame. Plastic foot. Refer to the list below for suitable fabrics for Dent Dressed. Please consult us for other fabric selections.

B502D is also available as an ordinary chair. Dent Dressed is also available as Dent with a wooden seat shell.

Fabric	Basic	1	2	3	4	Leather
B502D-65 Chrome	530	541	552	564	578	722
B502D-65 Black steel	547	556	569	583	595	739
B502D-82 Chrome	530	541	552	564	578	722
B502D-82 Black steel	547	556	569	583	595	739

Surcharge (+)

Felt-covered plastic feet or glides for various surfaces. Price/chair	6
Steel frame for B501D, B502D, 503D in custom RAL colour*	23

Surcharge, net (+)

Set-up charge for steel as per cc. 2a or cc. 2b. NET/ colour	220
*Set-up charge for steel in custom RAL colour NET/ colour	650

Recommended fabrics	Basic	1	2	3	4	Leather
	Xtreme	Flame	Brink	Canvas		Elmoitque
	X2	Step				

Stefan Borselius 2010

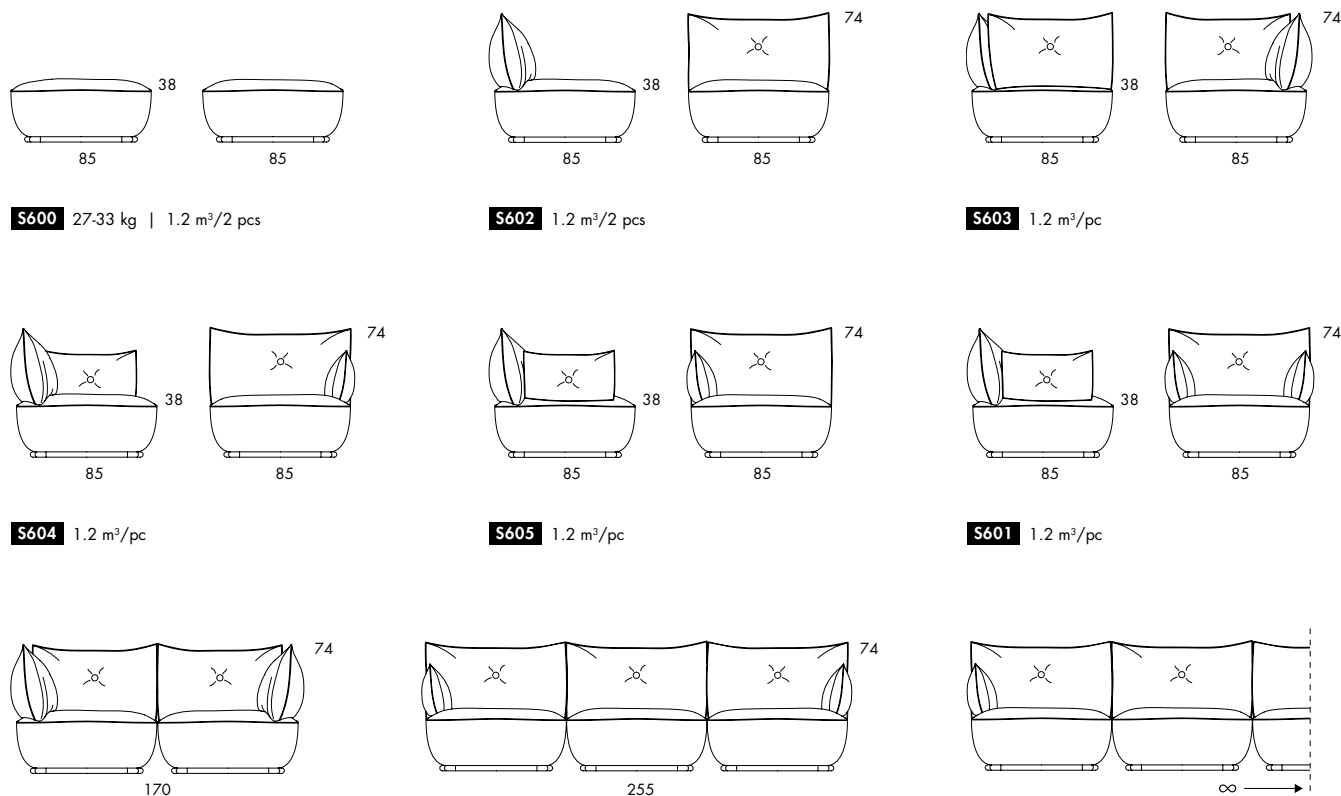
S60 | **DUNDER**

SECTIONAL SOFA | EASY CHAIR | FOOTSTOOL. Steel frame with no-sag springs. CMHR moulded polyurethane foam with fabric cover. Chrome-plated steel frame (chrome III). Plastic feet. Link fitting included with each add-on section. Dunder can be put together as preferred; a few examples are shown above. It's possible to make corner sofas or back-to-back sofas. Interliner included for D60 cushion.

Fabric	Xtreme	Basic	1	2	3	4
S600 Chrome Footstool	1 517	1 567	1 595	1 636	1 680	1 724
S602 Chrome Centre	2 089	2 167	2 213	2 275	2 339	2 408
S603 Chrome Corner	2 622	2 727	2 791	2 872	2 963	3 053
S604 Chrome End Left	2 453	2 550	2 608	2 681	2 763	2 845
S605 Chrome End Right	2 453	2 550	2 608	2 681	2 763	2 845
S601 Chrome Easy chair	2 836	2 949	3 019	3 108	3 203	3 302

Accessories

D60 Cushion 50x50 with button	145	162	171	182	195	210
-------------------------------	-----	-----	-----	-----	-----	-----

Surcharge (+)



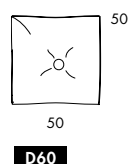

Buttons in contrasting colour, basic fabrics Price/pair	16
Buttons in contrasting colour, fabrics 1-4 Price/pair	31
Black leather buttons. Price/pair	16
Raised tubular steel frame Height +3 cm or +5 cm	289

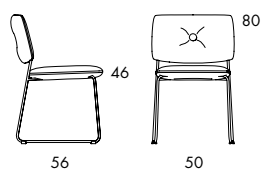
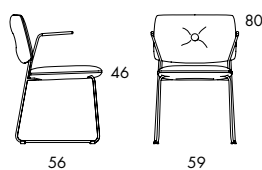

Surcharge, net (+)

*Set-up charge for frame in custom RAL colour NET/colour	650
--	-----

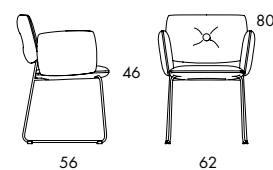
Stefan Borselius 2011, 2012, 2013

S70, S70A, S70AS | **DUNDRA****S70** 5.6 kg | 0.29 m³/pc **S70A** 6 kg | 0.29 m³/pc **S70AS** 9.15 kg | 0.32 m³/pc

CHAIR. Wood and steel frame. Moulded CMHR foam padding. Upholstered in fabric or leather. Leather as per colour chart. 6a. Chrome plated (chrome III) or black-painted steel frame. Plastic foot. S70 and S70A are stackable. S70A has rubber-covered armrests and S70AS has padded armrests.

Dundra is a large family that includes foot stools, chairs, bar stools, easy chairs, sofas and tables.

Fabric	Xtreme	Basic	1	2	3	4	Leather
S70 Chrome	609	642	663	689	717	747	897
S70 Black steel	634	667	689	716	742	772	923
S70 White steel	661	695	716	741	769	798	948
S70A Chrome	661	695	716	741	769	798	950
S70A Black steel	688	720	741	767	795	825	977
S70A Black steel	714	747	767	794	822	850	1 003
S70AS Chrome	1 086	1 134	1 163	1 198	1 239	1 281	1 558
S70AS Black steel	1 113	1 159	1 189	1 225	1 266	1 308	1 586
S70AS White steel	1 139	1 184	1 216	1 252	1 291	1 333	1 609

Surcharge (+)

Buttons in contrasting colour, basic fabrics Price/pair	16
Black leather buttons. Price/pair	16
Buttons in contrasting colour, fabrics 1-4 Price/pair	31
Frame lacquered as per cc. 2b*. Min. 8 pcs/colour*	23
Frame in custom RAL colour. Min. 8 pcs/colour **	23
Felt covered plastic foot. Price/chair	9

Surcharge, net (+)

*Set-up charge for steel as per cc. 2b. NET/colour	220
**Set-up charge for frame in custom RAL colour. NET/colour	650

Stefan Borselius 2013

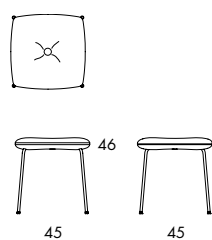
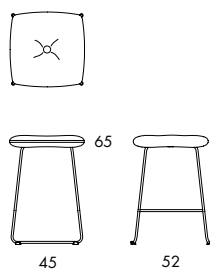
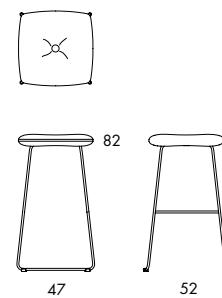
S73, S73-65, S73-82 | **DUNDRA****S73-46** 3.33 kg | 0.29 m³/5 pcs**S73-65** 4.2 kg | 0.20 m³/pc**S73-82** 4.7 kg | 0.24 m³/pc

STOOL | BARSTOOL. Wood and steel frame. Moulded CMHR foam padding. Upholstered in fabric or leather. Leather as per cc. 6a. Chrome plated (chrome III) or black-painted steel frame. Plastic foot.

Dundra is a large family that includes foot stools, chairs, barstools, easy chairs, sofas and tables.

Fabric	Xtreme	Basic	1	2	3	4	Leather
S73-46 Chrome	313	331	341	355	373	388	498
S73-46 Black steel	338	356	369	381	397	416	527
S73-46 White steel	364	383	392	408	425	441	552
S73-65 Chrome	431	450	463	478	492	511	622
S73-65 Black steel	458	478	489	502	519	536	648
S73-65 White steel	484	502	516	530	545	561	673
S73-82 Chrome	431	450	463	478	492	511	622
S73-82 Black steel	458	478	489	502	519	536	648
S73-82 White steel	484	502	516	530	545	561	673



Surcharge (+)

Buttons in contrasting colour, basic fabrics Price/pair	16
Black leather buttons. Price/pair	16
Buttons in contrasting colour, fabrics 1-4 Price/pair	31
Frame lacquered as per cc. 2b** . Min. 8 pcs/colour	23
Frame in custom RAL colour* . Min. 8 pcs	23
Felt covered plastic foot. Price/chair	9

Surcharge, net (+)

* *Set-up charge for steel as per cc. 2b. NET/colour	220
*Set-up charge for frame in custom RAL colour. NET/colour	650

Stefan Borselius 2013

S72-65, S72-82 | **DUNDRA****S72-65** 6.4 kg | 0.38 m³/2 pcs **S72-82** 6.9 kg | 0.44 m³/2 pcs 

STACKABLE BARSTOOL. Wood and steel frame. Moulded CMHR foam padding. Upholstered in fabric or leather. Leather as per cc. 6a. Chrome plated (chrome III) or black-painted steel frame. Plastic foot.

Dundra is a large family that includes foot stools, chairs, barstools, easy chairs, sofas and tables.

Fabric	Xtreme	Basic	1	2	3	4	Leather
S72-65 Chrome	684	717	736	763	791	819	966
S72-65 Black steel	709	742	763	789	816	844	994
S72-65 White steel	736	769	789	814	842	870	1 017
S72-82 Chrome	684	717	736	763	791	819	966
S72-82 Black steel	709	742	763	789	816	844	994
S72-82 White steel	736	769	789	814	842	870	1 017



Surcharge (+)

Buttons in contrasting colour, basic fabrics Price/pair	16
Black leather buttons. Price/pair	16
Buttons in contrasting colour, fabrics 1-4 Price/pair	31
Frame lacquered as per cc. 2b** . Min. 8 pcs/colour	23
Frame in custom RAL colour* . Min. 8 pcs	23
Felt covered plastic foot. Price/chair	9

Surcharge, net (+)

* Set-up charge for steel as per cc. 2b. NET/colour	220
** Set-up charge for steel in custom RAL colour. NET/colour	650

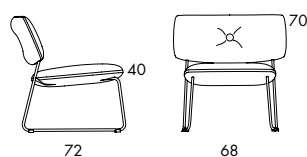
Stefan Borselius 2013

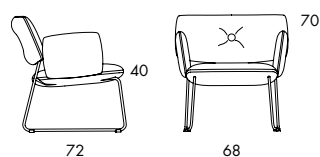
S71, S71AS | **DUNDRA**
S71 8.3 kg | 0.45 m³/2 pcs 

S71AS 11.4 kg | 0.45 m³/pc

EASY CHAIR. Wood and steel frame with no-sag springs. Moulded CMHR foam padding. Upholstered in fabric or leather. Leather as per cc. 6a. With or without arms. Chrome plated (chrome III) or black-painted steel frame. Plastic foot. S71 without armrests is stackable.

Dundra is a large family that includes foot stools, chairs, barstools, easy chairs, sofas and tables.

Fabric	Xtreme	Basic	1	2	3	4	Leather
S71 Chrome	813	860	889	927	967	1 010	1 297
S71 Black steel	840	887	916	952	994	1 033	1 322
S71 White steel	867	914	943	979	1 021	1 060	1 349
S71AS Chrome	1 265	1 322	1 359	1 405	1 456	1 508	1 903
S71AS Black steel	1 292	1 349	1 386	1 429	1 481	1 532	1 929
S71AS White steel	1 316	1 376	1 413	1 457	1 510	1 560	1 956



Surcharge (+)

Buttons in contrasting colour, basic fabrics Price/pair	16
Black leather buttons. Price/pair	16
Buttons in contrasting colour, fabrics 1-4	32
Frame lacquered as per cc. 2b** . Min. 8 pcs/colour	24
Frame in custom RAL colour* . Min. 8 pcs	24
Felt covered plastic foot. Price/chair	10

Surcharge, net (+)

**Set-up charge for steel as per cc. 2b. NET/colour	220
*Set-up charge for frame in custom RAL colour. NET/colour	650

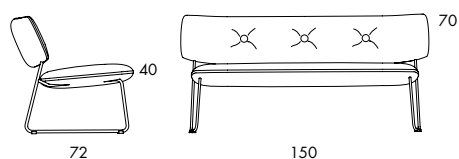
Stefan Borselius 2013

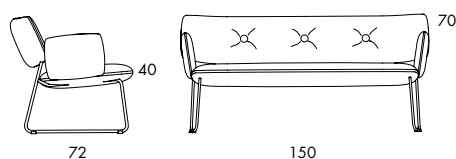
S74, S74A | **DUNDRA**
S74 19 kg | 1.0 m³/2 pcs 

S74A 22 kg | 0.9 m³/pc

SOFA. Steel frame with no-sag springs. CMHR moulded foam padding. Upholstered in fabric or leather. Leather as per colour chart. 6a. Chrome plated (chrome III) or black-painted steel frame. Plastic foot. Dundra S74 without armrests is stackable.

Dundra is a large family that includes foot stools, chairs, barstools, easy chairs, sofas and tables. Interliner included.

Fabric	Xtreme	Basic	1	2	3	4	Leather
S74 Chrome	1 843	1 935	1 993	2 063	2 140	2 222	2 983
S74 Black steel	1 866	1 960	2 018	2 088	2 168	2 247	3 010
S74 White steel	1 894	1 988	2 044	2 115	2 193	2 276	3 036
S74AS Chrome	2 341	2 449	2 516	2 601	2 691	2 788	3 579
S74AS Black steel	2 368	2 476	2 544	2 626	2 718	2 815	3 607
S74AS White steel	2 393	2 501	2 568	2 654	2 743	2 840	3 632

Surcharge (+)

Buttons in contrasting colour, basic fabrics Price/pair	47
Black leather buttons. Price/pair	47
Buttons in contrasting colour, fabrics 1-4 Price/pair	94
Frame lacquered as per cc. 2b**. Min. 8 pcs/colour	23
Frame in custom RAL colour*. Min. 8 pcs	23
Felt covered plastic foot. Price/chair	9

Surcharge, net (+)

**Set-up charge for steel as per cc. 2b. NET/colour	220
*Set-up charge for frame in custom RAL colour. NET/colour	650

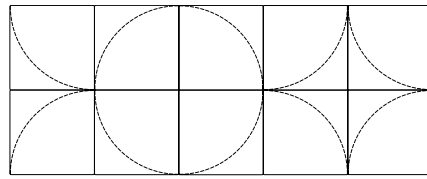
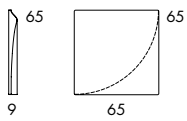
**A42**

SOUND ABSORBENT AND WALL DECORATION. 100% hot-moulded polyester form felt. Alternatively the formfelt can be covered in Blazer Lite from Camira, a fabric in 100% wool, available in 30 colors. Gaia is mounted on the wall with a steel bracket. Each Gaia can be rotated and placed in four different positions.

On our website www.blastation.com/downloads/gaia-wall-planner there is a Gaia tool that allows you to create your own wall combinations of form and colour.

A42 Light grey, medium grey or anthracite grey form felt	114
A42 Black or off-white form felt	114
A422 Form felt covered with Blazer Lite/Camira, min. 2 pcs/colour	161

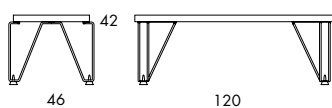

GS20

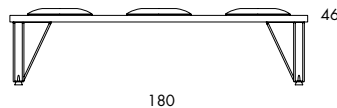

GS30 (D25)

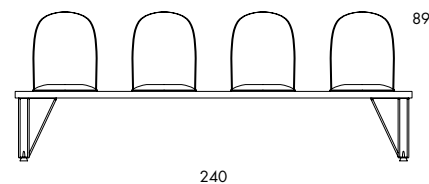

GS40 (D25 & D20)

BENCH SYSTEM. Bench top in solid, clear-lacquered birch, 40 mm thick. Galvanized steel frame. Gate is available in 3 straight (GS) and 2 round (GR) basic units that can be linked together to angled, round or straight bench units to best fit the intended setting. Benches may be fitted with backrests in compression moulded birch veneer and/or padded seats to suit tastes and requirements. The seats have CMHR polyurethane padding upholstered with fabric or leather. Leather as per colour chart. 6a. Standard seat pitch is 600mm (GS); can be varied to accommodate more (less legroom) or fewer (more legroom) seats. Please state when ordering if benches must be anchored to the floor.

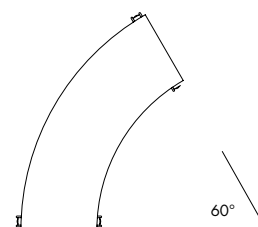

GR20

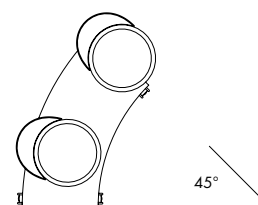

GR10

GS, GATE STRAIGHT

	Start-section	Extension
GS 20 Galvanized steel Birch 2-seat units 120 cm	978	823
GS 30 Galvanized steel Birch 3-seat units 180 cm	1 177	1 017
GS 40 Galvanized steel Birch 4-seat units 240 cm	1 645	1 469

GR, GATE ROUND, external radius 150 cm

GR 20 Galvanized steel Birch 2-seat units 1/6 circle 60°	1 236	1 056
GR 10 Galvanized steel Birch 1.5-seat units 1/8 circle 45°		961

If Gate GR is used as a free-standing bench, use at least 2x GR 20 linked in an S-shape or 3x GR 20 linked to form a semi-circle. If 2 pcs Gate GR 20 are use as a semi-circular free-standing bench, a half frame may be necessary. Please consult us.

Accessories	Xtreme	Basic	1	2	3	4	Leather
D25 Round seat Matches back D20	89	103	111	122	133	147	203
D28 Fully straight seat for GS20 No backs to match	313	325	334	344	356	370	1 064
D28 Fully straight seat for GS30 and GS40 No backs to match	436	489	522	564	609	656	1 119
D28 Fully round seat for GS20 No backs to match	328	353	369	386	406	428	1 064
D28 Fully round seat for GS10 No backs to match	281	300	313	325	341	358	1 027
D20 Rounded back, moulded, clearlacquered birch	175						

Surcharge (+)

Wall and bench spacer in galvanised steel. Price/item	44
D24 Armrest. Price/item	155
SZSBGA half frame in galvanised steel (for curved units)	138
SZGDGA Prepared for floor anchoring Price/frame	47

Surcharge (+)

D20 Stained back in lacquered birch, as per cc. 4*	23
GS, GR Stained bench in lacquered birch, as per cc. 4*	23

Surcharge, net (+)

*Set-up charge for back finished as per cc. 4. NET/colour	100
**Set-up charge for bench finished as per cc. 4. NET/colour	100

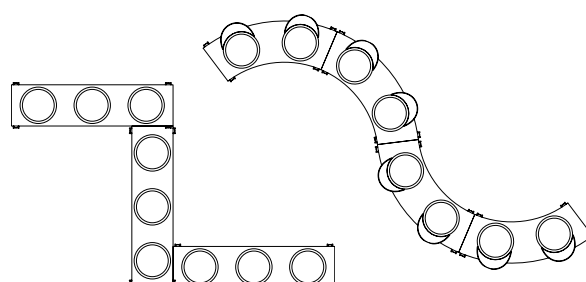
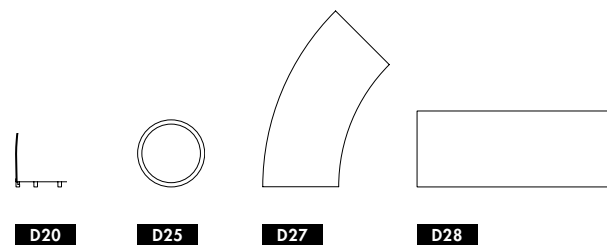

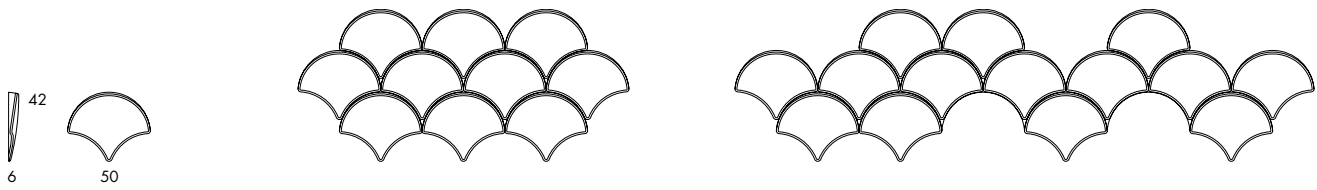

A40 0.3 kg | 0.1 m³/1-10 pcs

SOUND ABSORBENT AND WALL DECORATION. 100% hot-moulded polyester form felt. Alternatively the formfelt can be covered in Blazer Lite from Camira, a fabric in 100% wool, available in 30 colors. Magnetic attachment.

On our website www.blastation.com/downloads/ginkgo-wall-planner there is a Ginkgo tool that allows you to create your own wall combinations of form and colour.

A40 Light grey, medium grey or anthracite grey form felt	67
A40 Black or off-white form felt	70
A402 Form felt covered with Blazer Lite/Camira, min. 4 pcs/colour	86

Thomas Bernstrand + Lindau & Borselius 2015

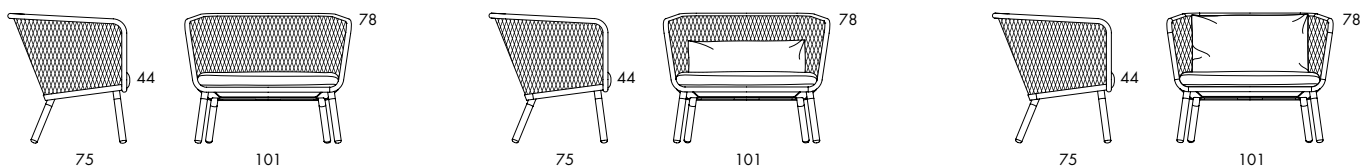
O141, O142, O143 | **HONKEN****O141** 22.4 kg | 0.9 m³/pc (1.7 m³/2 pcs)**O142** 23.8 kg | 0.9 m³/pc (1.7 m³/2 pcs)**O143** 24 kg | 0.9 m³/pc (1.7 m³/2 pcs)

GENEROUS EASY CHAIR. Steel basket and leg fittings of painted tubular steel and flattened expanded metal. Black-painted steel, fine texture, as per cc. 2a alternative in satin finish as per cc. 2b. Oiled oak legs. Seat/lumbar cushions of polyester foam and down. The seat and back cushions are fabric or leather covered. Leather as per colour chart. Ób. Removable covers.

Accessory for Honken always matches colour chosen for the Honken chair if they are ordered at the same time. If accessories are purchased to supplement an existing Honken, the colour must be specified on the Honken accessory. Ottoman have CMHR polyurethane padding upholstered with fabric or leather. Interliner included.

Fabric	Xtreme	Basic	1	2	3	4	Leather
O141 Black steel Oak legs Seat cushions	1 791	1 833	1 858	1 894	1 930	1 967	2 720
O141 Tomato red cc. 2b Oak legs Seat cushions	1 791	1 833	1 858	1 894	1 930	1 967	2 720
O141 Taupe cc. 2b Oak legs Seat cushions	1 791	1 833	1 858	1 894	1 930	1 967	2 720
O142 Black steel Oak legs Seat and lumbar cushion	1 884	1 944	1 976	2 022	2 070	2 119	3 172
O142 Tomato red cc. 2b Oak legs Seat and lumbar cushion	1 884	1 944	1 976	2 022	2 070	2 119	3 172
O142 Taupe cc. 2b Oak legs Seat and lumbar cushion	1 884	1 944	1 976	2 022	2 070	2 119	3 172
O143 Black steel Oak legs Seat and high back cushion	2 098	2 183	2 255	2 328	2 408	2 506	3 459
O143 Tomato red cc. 2b Oak legs Seat and high back cushion	2 098	2 183	2 255	2 328	2 408	2 506	3 459
O143 Taupe cc. 2b Oak legs Seat and high back cushion	2 098	2 183	2 255	2 328	2 408	2 506	3 459

Accessories

D44 Ottoman Removable, placed left or right	553	594	636	673	716	772	820
D451 Fixed, straight table in oil or lacquered oak	273						
D452 Fixed, L-shaped table in oil or lacquered oak	322						
D941EU incl D9412 Allocacoc PowerCube Original USB socket F (EU), 3 power, 2 USB charging	109						
D941EU incl D9413 Allocacoc PowerCube Original USB socket G (UK), 3 power, 2 USB charging	109						
D942US incl D9422 Allocacoc PowerCube Original USB socket B (USA), 3 power, 2 USB charging	109						
Electric cord in textile (EU) 3m, Color: Copper or Black	47						

Surcharge, net (+)

Set-up charge for frames in other colours as per cc. 2b. NET/colour	220
Set-up charge for frame in custom RAL colour NET/colour	650

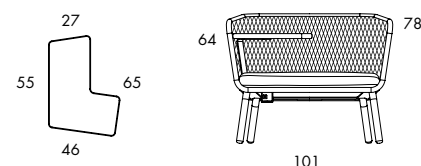
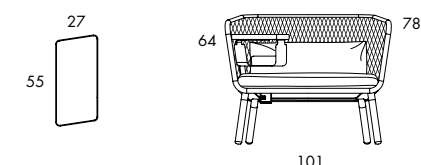
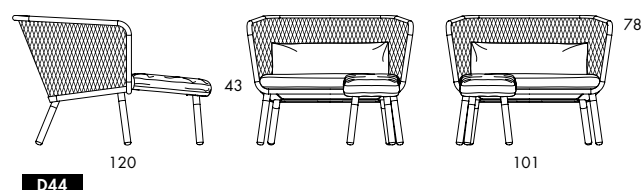
**D452****D452 + D941****D451****D451 + D453 + D941****D44**

Thomas Bernstrand + Lindau & Borselius 2017

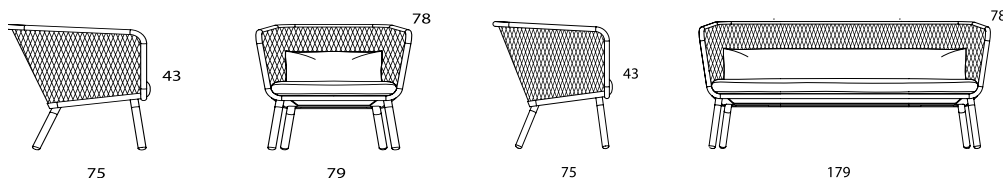
S, XL | **HONKEN****O145** 21.1 kg**O148** 58.8 kg

SMALL EASY CHAIR AND SOFA. Steel basket and leg fittings of painted tubular steel and flattened expanded metal. Lacquered steel, fine texture, as per cc. 2a or cc. 2b. Oiled oak legs. Seat/lumbar cushions of polyester foam and down. The seat and back cushions are Reversible and covered in fabric or leather. Leather as per cc. 6b. Removable covers.

Accessory for Honken always matches colour chosen for the Honken chair if they are ordered at the same time. If accessories are purchased to supplement an existing Honken, the colour must be specified on the Honken accessory. Interliner included.

Fabric	Xtreme	Basic	1	2	3	4	Leather
Honken S							
O144 Black steel Oak legs Seat cushions	1 609	1 633	1 664	1 695	1 722	1 773	2 059
O144 Tomato red cc. 2b Oak legs Seat cushions	1 609	1 633	1 664	1 695	1 722	1 773	2 059
O144 Taupe cc. 2b Oak legs Seat cushions	1 609	1 633	1 664	1 695	1 722	1 773	2 059
Honken S XL							
O145 Black steel Oak legs Seat and lumbar cushion	1 781	1 812	1 869	1 906	1 942	2 000	2 466
O145 Tomato red cc. 2b Oak legs Seat and lumbar cushion	1 781	1 812	1 869	1 906	1 942	2 000	2 466
O145 Taupe cc. 2b Oak legs Seat and lumbar cushion	1 781	1 812	1 869	1 906	1 942	2 000	2 466
Honken XL							
O147 Black steel Oak legs Seat cushions	4 375	4 429	4 487	4 531	4 590	4 664	5 217
O147 Tomato red cc. 2b Oak legs Seat cushions	4 375	4 429	4 487	4 531	4 590	4 664	5 217
O147 Taupe cc. 2b Oak legs Seat cushions	4 375	4 429	4 487	4 531	4 590	4 664	5 217
Honken XL XL							
O148 Black steel Oak legs Seat and lumbar cushion	4 687	4 778	4 859	4 934	5 000	5 109	5 758
O148 Tomato red cc. 2b Oak legs Seat and lumbar cushion	4 687	4 778	4 859	4 934	5 000	5 109	5 758
O148 Taupe cc. 2b Oak legs Seat and lumbar cushion	4 687	4 778	4 859	4 934	5 000	5 109	5 758
Honken XL XL XL							
O149 Black steel Oak legs Seat and high back cushion	4 859	4 937	5 023	5 098	5 164	5 273	5 922
O149 Tomato red cc. 2b Oak legs Seat and high back cushion	4 859	4 937	5 023	5 098	5 164	5 273	5 922
O149 Taupe cc. 2b Oak legs Seat and high back cushion	4 859	4 937	5 023	5 098	5 164	5 273	5 922

Accessories

D941EU incl D9412 Allocacoc PowerCube Original USB socket F (EU), 3 power, 2 USB charging	109
D941EU incl D9413 Allocacoc PowerCube Original USB socket G (UK), 3 power, 2 USB charging	109
D942US incl D9422 Allocacoc PowerCube Original USB socket B (USA), 3 power, 2 USB charging	109
Electric cord in textile (EU) 3m, Color: Copper or Black	47

Surcharge, net (+)

Set-up charge for frames in other colours as per cc. 2b. NET/colour	220
Set-up charge for frame in custom RAL colour NET/colour	650

Thomas Bernstrand + Lindau & Borselius 2015

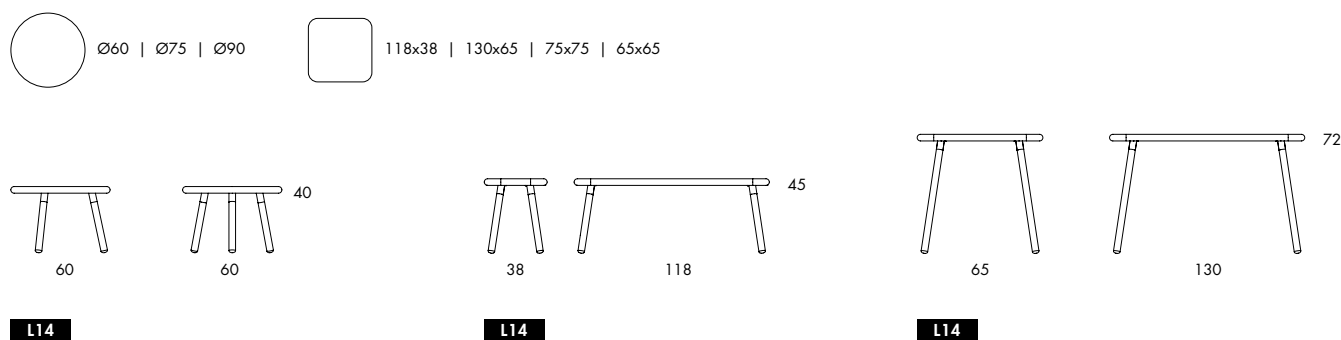
L14 | **HONKEN**

COFFEE TABLE | TABLE | BENCH. Tabletop and legs in solid, oiled or clear-lacquered oak. Steel leg brackets, black fine texture paint, as per cc. 2a alternative in satin finish as per selection in cc. 2b. Tabletop thickness 40 mm.

Coffee table (cm) Height 40 cm or 45 cm	Ø60	Ø75	Ø75	Ø90	Ø90
Number of legs	3	3	4	3	4
L14 Black steel Lacquered or oiled oak	769	1 016	1 125	1 319	1 428
L14 Tomato red cc. 2b Clear-lacquered or oiled oak	769	1 016	1 125	1 319	1 428
L14 Taupe cc. 2b Clear-lacquered or oiled oak	769	1 016	1 125	1 319	1 428

Coffee table/bench (cm) Height 40 cm or 45 cm	118x38	130x65	65x65	75x75
Number of legs	4	4	4	4
L14 Black steel Lacquered or oiled oak	989	1 483	956	1 128
L14 Tomato red cc. 2b Clear-lacquered or oiled oak	989	1 483	956	1 128
L14 Taupe cc. 2b Clear-lacquered or oiled oak	989	1 483	956	1 128

Table (cm) Height 72 cm	130x65	65x65	75x75	Ø75	Ø90
Number of legs	4	4	4	3	4
L14 Black steel Lacquered or oiled oak	1 514	986	1 159	1 041	1 458
L14 Tomato red cc. 2b Clear-lacquered or oiled oak	1 514	986	1 159	1 041	1 458
L14 Taupe cc. 2b Clear-lacquered or oiled oak	1 514	986	1 159	1 041	1 458

Surcharge, net (+)

Setup charge for steel in other colours as per cc. 2b. NET/colour	220
Setup charge for steel in custom RAL colour. NET/colour	650

Other finishes available for projects.

Börge Lindau 1986

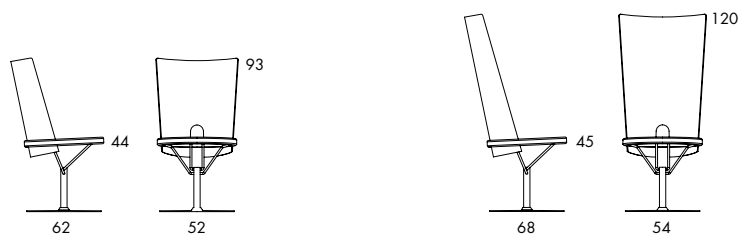
B8M, B8L | **HÖVDING****B8M** 12.5 kg | 0.36 m³/pc**B8L** 14 kg | 0.44 m³/pc

SWIVEL CHAIR. Seat ring in compression moulded, layer-glued lacquered birch. Seat in compression moulded, layer-glued lacquered birch. Back in birch veneer covered in leather. Tärnsjö leather as per cc. 5. Steel frame with stainless steel crown and painted footplate as per cc. 2a with fine textured finish.

B8M Stainless steel pedestal Grey foot Clear-lacquered birch in seat ring Leather back & seat centre cc. 5	1 972
--	--------------

B8L Stainless steel pedestal Grey foot Clear lacquered birch in seat ring Leather back & seat centre cc. 5	1 988
--	--------------

Surcharge (+)

Padded seat in leather as per cc. 6a	233
Swivel base, prepared for floor mounting Ø250 mm	25

Other finishes available for projects.

Fredrik Mattson 2001

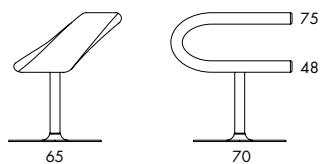
O70 | **INNOVATION C****O70** 23 kg | 0.45 m³/pc

MULTI-FUNCTIONAL SWIVELLING STOOL. Steel frame. Moulded CMHR foam padding. Upholstered in fabric or leather. Leather as per cc. 6a. Steel swivel base with stainless steel pedestal and silver-painted footplate. 2a with fine textured finish.

There is an optional, removable writing surface in compression moulded, layer-glued veneer with painted steel features. Refer to the list below for suitable fabrics for Innovation C. Please consult us for other fabric selections.

Fabric	Xtreme	Basic	1	2	3	4	Leather
O70 Stainless steel pedestal Silver-painted footplate	2 002	2 073	2 123	2 177	2 228	2 281	2 716

Accessories

D70 Removable writing surface Clear-lacquered ash	194
D70 Removable writing surface Clear-lacquered oak	194
D70 Removable writing surface Black ash	209
D70 Removable writing surface White ash	209

Surcharge (+)

Swivel base with auto-return	23
Base ready for floor anchoring Ø250mm	23

Recommended fabrics	Xtreme	Basic	1	2	3	4	Leather
*Innovation C covered in vinyl/artificial leather may develop small creases along the seams.	X2	Aquarius	Crisp	Divina 3	Sunniva 2	Elmo Soft	
	Blazer	Hemp	Luna 2	Divina Melange	Balder 3		
	Mainline Plus	Europost 2	Tonus 4	Divina MD	Outback		
	Mainline Flax	Gaja Classic	Tonus Meadow	Steelcut 2			
	Step	Fame	Tonica	Steelcut Trio 2			
	Step melange	Remix 2	Clara 2	Hallingdal 65			
		Flex	Memory	Canvas			
		Soft	Brink	Rime			
		Synergy	Silk	Rami			
		Shimmer	Breeze Fusion	Rami Plus			
		Step	Fame Hybrid	Stamskin Top*			
			Valencia*	Moor			
			Silververtex*	Fiord			
			Breeze	Molly 2			
			Capture				
			Rock				
			Bowen				

Tomoyuki Matsuoka 2001

O80, O82 | ISLAND

**O80** 10-12 kg | 0.18 m³/pc**O82** 15-17 kg | 0.21 m³/pc

FOLDING BENCH. Plywood frame. Padding of CMHR polyurethane foam. Upholstered in fabric or leather. Leather as per colour chart. 6a. Chrome-plated steel frame (chrome III). Plastic feet.

Fabric	Xtreme	Basic	1	2	3	4	Leather
O80 Chrome	1 467	1 517	1 564	1 606	1 645	1 714	2 411
O82 Chrome	1 661	1 714	1 761	1 803	1 853	1 939	2 742

Tomoyuki Matsuoka 2001

L80, L82 | ISLAND

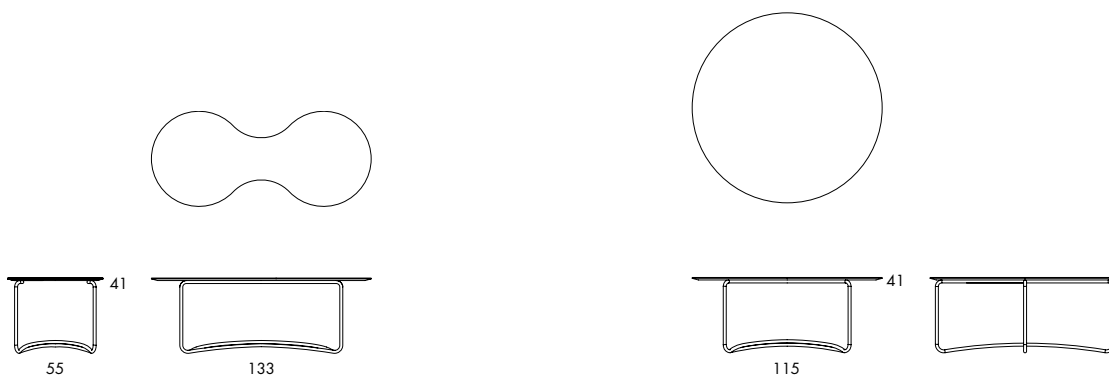

**L80** 10.3 kg | 0.18 m³/pc**L82** 10.3 kg | 0.21 m³/pc

FOLDING TABLE. Chrome-plated steel frame (chrome III). Tabletop in plywood with with laminate or wood veneer finish. Plastic feet.

L80 Chrome White laminate	1 138
L80 Chrome Oak veneer	1 214
L82 Chrome White laminate	1 350
L82 Chrome Oak veneer	1 489

Other finishes available for projects.

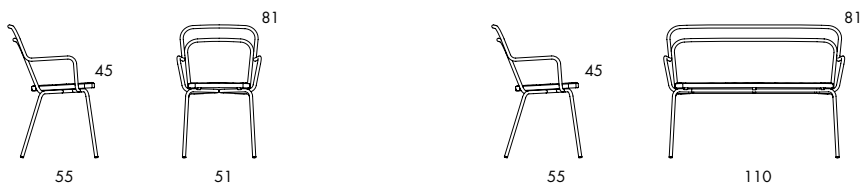
Thomas Bernstrand 2014

O11, O12 | **KAFFE**
O11 5.9 kg | 0.32 m³/1-3 pcs 
O12 10.6 kg | 1.06 m³/1-4 pcs 

STACKABLE CHAIR | BENCH. For indoor and outdoor use. Tubular steel frame. Galvanized steel painted black or light grey as per cc. 2a with fine textured finish. Moulded polyurethane seat, PUR Plastic feet.

O11 Black frame Black seat	380
O11 Light grey frame Light grey seat	416
O11 Frame in custom RAL colour. Min. 8 pcs/colour	416

O12 Black frame Black seat	845
O12 Light grey frame Light grey seat	864
O12 Frame in custom RAL colour. Min. 8 pcs/colour	864

Surcharge, net (+)

*Set-up charge for frame in custom RAL colour, NET/colour	650
---	------------

NOTE! Always select light grey or black seats for frames in custom RAL colours.

Thomas Bernstrand 2014

L11 | **KAFFE****L11**

TABLE. Table with galvanized, painted tubular steel legs. Tabletops in solid oak and valchromat intended for indoor use. Plastic feet. The table is easy to take apart. Table top thickness 25 mm.

The coffee table is available in many sizes and heights. Coffee tables for outdoor use; see next page.

Tabletop (cm) Height 40 and 50 cm	Ø45	Ø60	Ø75	Ø90	Ø90
Number of legs	3	3	3	3	4
L11 Black steel Clear-lacquered or oiled oak	434	544	645	808	895
L11 Black steel Black-stained oak	484	605	725	933	1019
L11 Black steel Clear-lacquered black Valchromat	356	445	591	664	728

Tabletop (cm) Height 40 and 50 cm	118x38	65x65	118x65
Number of legs	4	4	4
L11 Black steel Clear-lacquered or oiled oak	619	595	859
L11 Black steel Black-stained oak	681	658	984
L11 Black steel Clear-lacquered black Valchromat	548	653	700

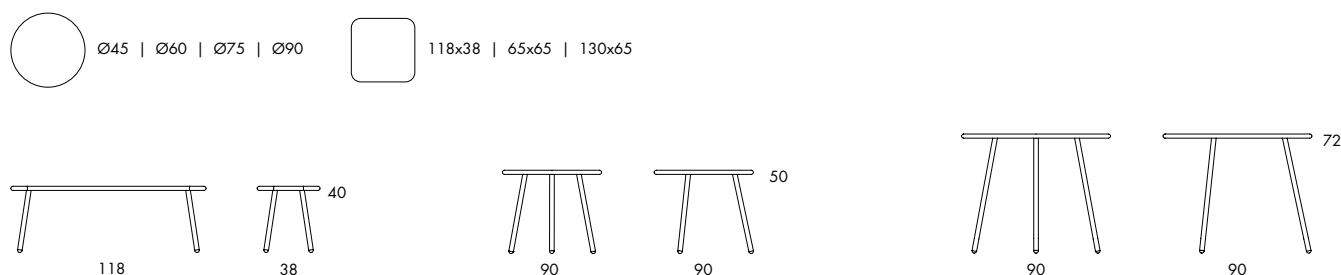
Tabletop (cm) Height 72 cm	Ø60	Ø75	Ø90	65x65	130x65
Number of legs	3	3	3	4	4
L11 Black steel Clear-lacquered or oiled oak	544	645	808	595	878
L11 Black steel Black-stained oak	605	725	933	658	1006
L11 Black steel Clear-lacquered black Valchromat	445	591	664	653	720

Surcharge (+)

Table legs light grey cc. 2a fine textured finish. Price/table	16
*Table legs in custom RAL colour. Price/table. Min. 8 pcs/colour	16

Surcharge, net (+)

*Set-up charge for steel legs in custom RAL colour. NET/colour	650
--	-----

Other finishes available for projects.

Thomas Bernstrand 2014

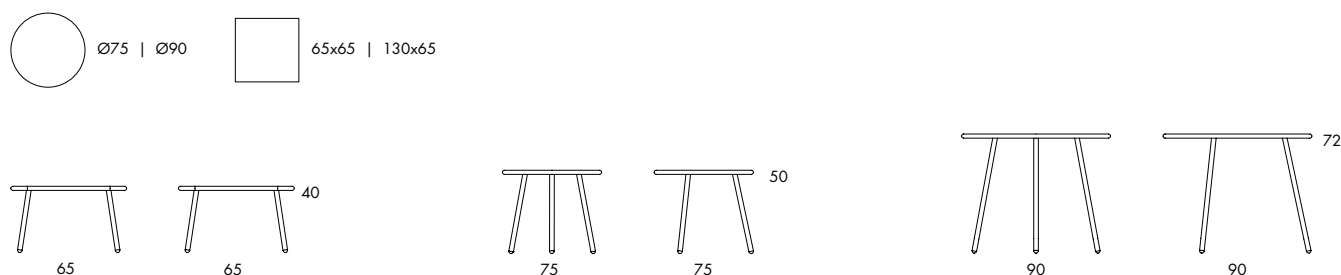
L11S | **KAFFE****L11S**

STEEL TABLE. Table with tabletop and legs in galvanized, painted steel suitable for outdoor use. Painted according to selection from cc. 2a with fine textured finish. Plastic feet. The table is easy to dismount.

The coffee table is available in many sizes and heights. Coffee tables for indoor use; see previous page.

Steel tabletop (cm) Height 72 cm	65x65	130x65	Ø75	Ø90	Ø90
Number of legs	4	4	3	3	4
L11S Black steel legs Black-painted tabletop	575	741	730	848	892
L11S Light grey steel legs Light grey-painted tabletop	609	775	764	883	927
L11S Table finished in custom RAL colour* Min. 2 pcs/colour	609	775	764	883	927

Steel tabletop (cm) Height 40 or 50 cm	65x65	130x65	Ø75
Number of legs	4	4	3
L11S Black steel legs Black-painted tabletop	553	720	714
L11S Light grey steel legs Light grey-painted tabletop	589	756	750
L11S Table finished in custom RAL colour*	589	756	750

Surcharge, net (+)

*Set-up charge for table in custom RAL colour, NET/colour	650
---	------------

Other finishes available for projects.

Fredrik Mattson 2009

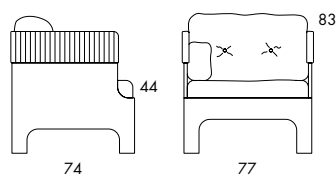
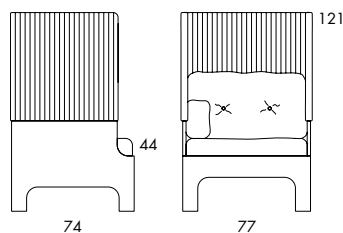
S51L, S51H | **KOJA****S51L** 25 kg | 0.6 m³/pc**S51H** 35 kg | 0.85 m³/pc

LOW EASY CHAIR | HIGH EASY CHAIR. Frame in compression moulded, layer-glued veneer with stained ash finish. No-sag springs. Sound absorbing hood in Europost Welded fabric. Seat cushion, back cushion and small side cushion in polyester and down covered with fabric or leather. Upholstered buttons.

Koja is also available as a 2-seat and 3-seat sofa. Interliner included.

Fabric	Xtreme	Basic	1	2	3	4
S51L Clear-lacquered ash Hood in Europost Welded Cushions	4 367	4 442	4 519	4 519	4 650	4 650
S51L Black ash Hood in Europost Welded Cushions	4 367	4 442	4 519	4 519	4 650	4 650
S51L White ash Hood in Europost Welded Cushions	4 367	4 442	4 519	4 519	4 650	4 650
S51H Clear-lacquered ash Hood in Europost Welded Cushions	5 282	5 361	5 466	5 466	5 586	5 586
S51H Black ash Hood in Europost Welded Cushions	5 282	5 361	5 466	5 466	5 586	5 586
S51H White ash Hood in Europost Welded Cushions	5 282	5 361	5 466	5 466	5 586	5 586

Surcharge (+)

Cushions in different colours/fabrics from same fabric category.	72	113	147	147	220	220
S51L Fabric hood with stitched channels	17	34	42	52	59	67
S51H Fabric hood with stitched channels	52	127	177	228	288	345

Accessories

Rotatable writing surface* Clear-lacquered ash or oak veneer	467
Rotatable writing surface* Black or white painted ash veneer	483

*Handed left or right

Colours in Europost Welded; see www.gabriel.dk

Other finishes available for projects.

Fredrik Mattson 2009

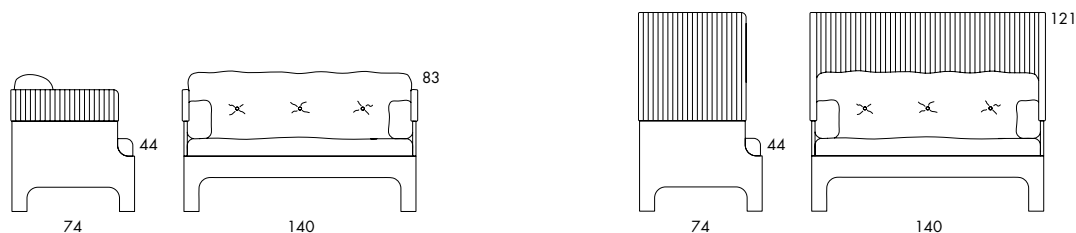
S53L, S53H | **KOJA****S53L** 34 kg | 0.95 m³/pc**S53H** 47 kg | 1.4 m³/pc

LOW 2-SEAT SOFA | HIGH 2-SEAT SOFA. Frame in compression moulded, layer-glued veneer with stained ash finish. No-sag springs. Sound absorbing hood in Europost Welded fabric. Seat cushion, back cushion and small side cushion in polyester and down covered with fabric or leather. Upholstered buttons.

Koja is also available as an easy chair and a 3-seat sofa. Interliner included.

Fabric	Xtreme	Basic	1	2	3	4
S53L Clear-lacquered ash Hood in Europost Welded Cushions	6 257	6 384	6 509	6 509	6 717	6 717
S53L Black ash Hood in Europost Welded Cushions	6 257	6 384	6 509	6 509	6 717	6 717
S53L White ash Hood in Europost Welded Cushions	6 257	6 384	6 509	6 509	6 717	6 717
S53H Clear-lacquered ash Hood in Europost Welded Cushions	7 641	7 766	7 890	7 890	8 099	8 099
S53H Black ash Hood in Europost Welded Cushions	7 641	7 766	7 890	7 890	8 099	8 099
S53H White ash Hood in Europost Welded Cushions	7 641	7 766	7 890	7 890	8 099	8 099

Surcharge (+)

Cushions in different colours/fabrics from same fabric category.	72	113	147	147	220	220
S53L Fabric hood with stitched channels	17	38	47	59	69	78
S53H Fabric hood with stitched channels	52	144	203	270	338	414

Accessories

Rotatable writing surface* Clear-lacquered ash or oak veneer	467
Rotatable writing surface* Black or white painted ash veneer	483

*Handed left or right

Colours in Europost Welded; see www.gabriel.dk

Other finishes available for projects.

Fredrik Mattson 2009

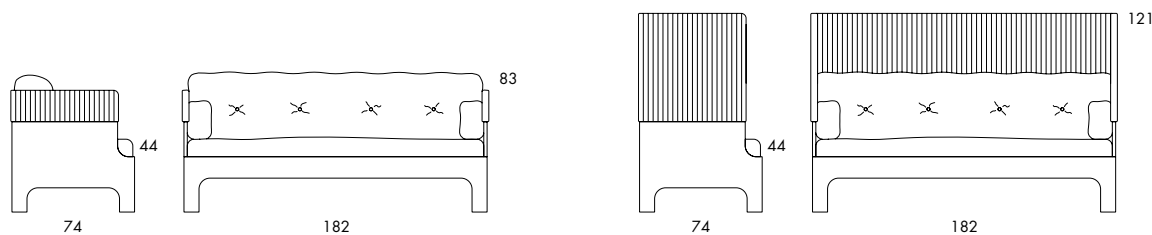
S52L, S52H | **KOJA****S52L** 40 kg | 1.35 m³/pc**S52H** 60 kg | 2.0 m³/pc

LOW 3-SEAT SOFA | HIGH 3-SEAT SOFA. Frame in compression moulded, layer-glued veneer with stained ash finish. No-sag springs. Sound absorbing hood in Europost Welded fabric. Seat cushion, back cushion and small side cushion in polyester and down covered with fabric or leather. Upholstered buttons.

Koja is also available as an easy chair and a 2-seat sofa. Interliner included.

Fabric	Xtreme	Basic	1	2	3	4
S52L Clear-lacquered ash Hood in Europost Welded Cushions	7 166	7 315	7 466	7 466	7 716	7 716
S52L Black ash Hood in Europost Welded Cushions	7 166	7 315	7 466	7 466	7 716	7 716
S52L White ash Hood in Europost Welded Cushions	7 166	7 315	7 466	7 466	7 716	7 716
S52H Clear-lacquered ash Hood in Europost Welded Cushions	8 691	8 840	8 991	8 991	9 243	9 243
S52H Black ash Hood in Europost Welded Cushions	8 691	8 840	8 991	8 991	9 243	9 243
S52H White ash Hood in Europost Welded Cushions	8 691	8 840	8 991	8 991	9 243	9 243

Surcharge (+)

Cushions in different colours/fabrics from same fabric category.	72	113	147	147	220	220
S52L Fabric hood with stitched channels	17	42	56	69	83	95
S52H Fabric hood with stitched channels	52	169	228	313	406	498

Accessories

Rotatable writing surface* Clear-lacquered ash or oak veneer	467
Rotatable writing surface* Black or white painted ash veneer	483

*Handed left or right

Colours in Europost Welded; see www.gabriel.dk

Other finishes available for projects.

Fredrik Mattson 2014

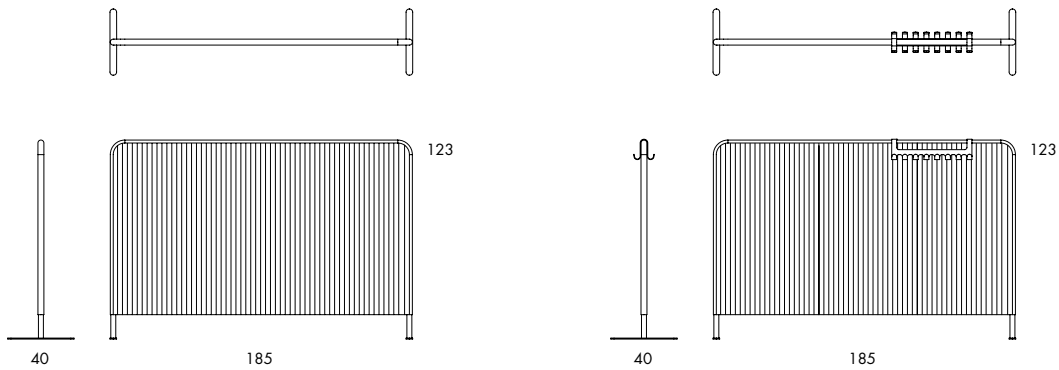
A50 | **KOJA ELEMENT****A50** 20 kg | 0.3 m³/pc (knock down)

SOUND ABSORBING ROOM DIVIDER. Chrome plated (chrome III) or black-painted steel frame. Filling of sound-absorbing eco felt. Polyester padded cover covered with Europost Welded or selected fabric with stitched channels.

A50 Chrome Cover in Europost Welded	2 073
A50 Black steel Cover in Europost Welded	2 073

Fabric	Xtreme	Basic	1	2	3	4
A50 Chrome Cover in fabric with stitched channels	2 583	2 730	2 823	2 938	3 064	3 197
A50 Black steel Cover in fabric with stitched channels	2 583	2 730	2 823	2 938	3 064	3 197

Accessories

D51 Chrome or black steel Removable hanger	97
--	-----------

Colours in Europost Welded; see www.gabriel.dk

Other finishes available for projects.

Börge Lindau 1987

L1

TABLE. Table edging in compression moulded, layer-glued birch veneer, clear lacquered or black stained. Smoked glass tabletop. Grey lacquered steel painted pedestal & footplate as per cc. 2a with fine textured finish. Stainless steel crown. Footplate Ø45.

Table (cm) Height 59 cm	Ø58
L1 Stainless steel crown Grey foot Clear-lacquered birch Glass top	958
L1 Stainless steel crown Grey foot Black-stained birch Glass top	958

Table (cm) Height 71 cm	Ø58
L1 Stainless steel crown Grey foot Clear-lacquered birch Glass top	966
L1 Stainless steel crown Grey foot Black-stained birch Glass top	966

Bar table (cm) Height 89 cm	Ø58
L1 Stainless steel crown Grey foot Clear-lacquered birch Glass top	975
L1 Stainless steel crown Grey foot Black-stained birch Glass top	975

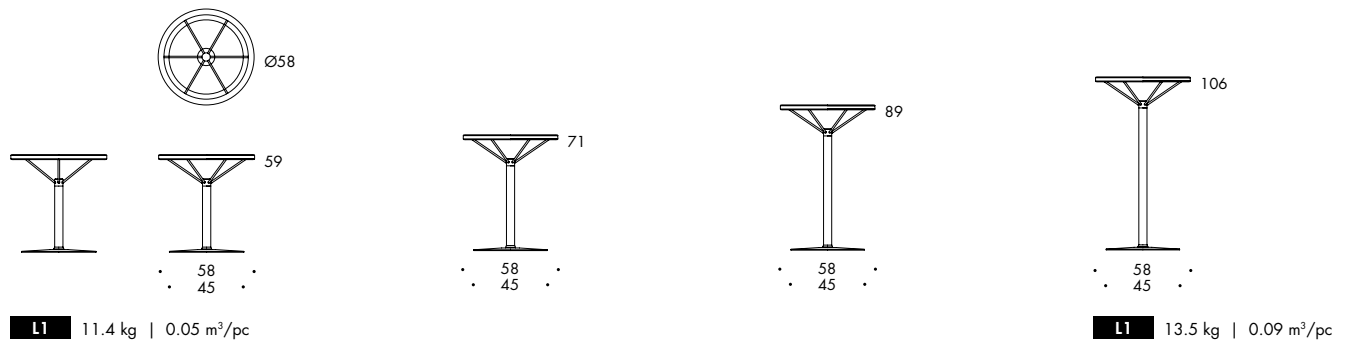
Bar table (cm) Height 106 cm	Ø58
L1 Stainless steel crown Grey foot Clear-lacquered birch Glass top	983
L1 Stainless steel crown Grey foot Black-stained birch Glass top	983

Stefan Borselius & Fredrik Mattson 2004

L32 | LEVEL



L32 13.5–27.5 kg | 0.054–0.15 m³/pc

TABLE. For indoor or outdoor use. Footplate in die-cast, tumble-polished aluminium. Pedestal L31 in natural anodised or black aluminium. Tabletop in white compact laminate with black core, thickness 12 mm, rounded edges. 70x140 has two frames. Foot 43x43 cm.

Tabletop (cm) Height 50 cm	Ø60	Ø75	Ø90	50x50	70x70	70x140
L32 Natural aluminium foot Natural pedestal White compact laminate	780	823	850	677	813	1 514
L32 Natural aluminium foot Black pedestal White compact laminate	825	869	897	722	859	1 559

Tabletop (cm) Height 60 cm	Ø60	Ø75	Ø90	50x50	70x70	70x140
L32 Natural aluminium foot Natural pedestal White compact laminate	780	823	850	677	813	1 514
L32 Natural aluminium foot Black pedestal White compact laminate	825	869	897	722	859	1 559

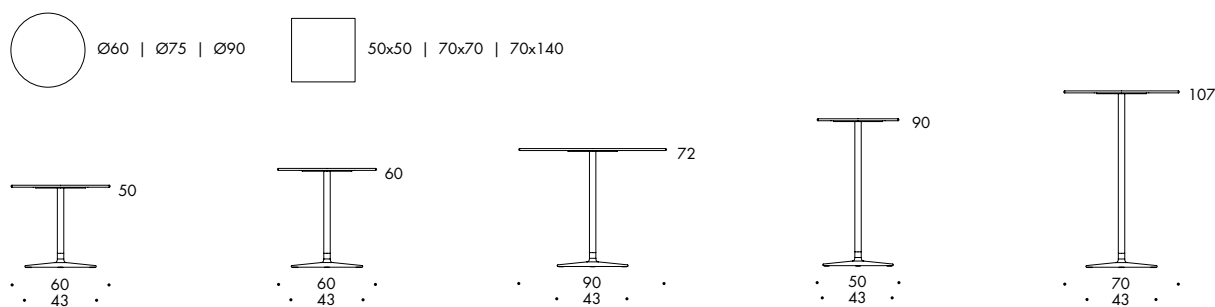
Tabletop (cm) Height 72 cm	Ø60	Ø75	Ø90	50x50	70x70	70x140
L32 Natural aluminium foot Natural pedestal White compact laminate	780	823	850	677	813	1 514
L32 Natural aluminium foot Black pedestal White compact laminate	825	869	897	722	859	1 559

Tabletop (cm) Height 90 cm	Ø60	50x50
L32 Natural aluminium foot Natural pedestal White compact laminate	797	695
L32 Natural aluminium foot Black pedestal White compact laminate	842	739

Tabletop (cm) Height 107 cm	Ø60	50x50
L32 Natural aluminium foot Natural pedestal White compact laminate	797	695
L32 Natural aluminium foot Black pedestal White compact laminate	842	739

Surcharge (+)

Footplate in matte black finish	41
---------------------------------	----

Galvanised or lacquered steel pedestals available for contract projects.

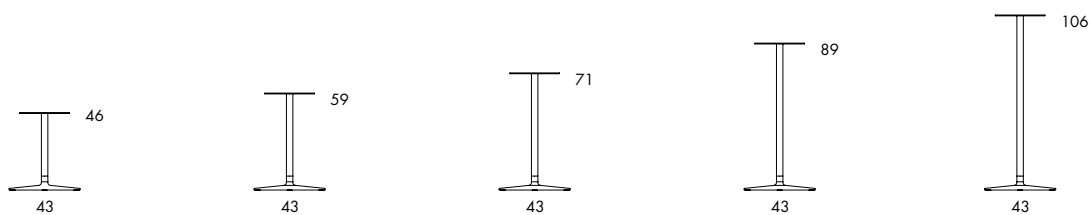

L31 8.8–11.2 kg | 0.023–0.025 m³/pc

PEDESTAL. For indoor and outdoor use. Footplate in die-cast, tumble-polished aluminium. Pedestal in natural anodised aluminium. Foot 43x43 cm. Pedestal 4x4 cm.

Table base, height (cm)	46	57	71	89	106
L31 Natural aluminium foot Natural pedestal	444	444	444	461	461
L31 Natural aluminium foot Black pedestal	489	489	489	506	506

Surcharge (+)

Footplate in matte black finish	41
---------------------------------	----

Recommended max sizes for tabletops

Base height 46 cm	Ø90	70x70
Base height 59 cm	Ø90	70x70
Base height 71 cm	Ø90	70x70
Base height 89 cm	Ø70	65x65
Base height 106 cm	Ø60	50x50

Standard tabletops; see price list on last page.

Available for projects

Other tabletops

Galvanised or painted steel pedestals

Painted finishes

Luka Stepan 2017

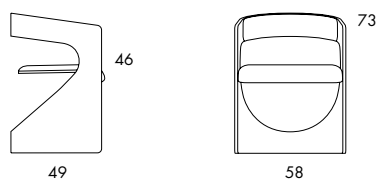
B17 | **LUCKY****B17** 0.32 m³/pc

CHAIR. Frame in moulded laminated oak, clear lacquered or stained finish as per selection from cc. 4. Padding of polyether. Seat and backrest upholstered in fabric or leather as per cc. 6b. Plastic feet.

Lucky is only available with seat and back upholstered in Mainline Flax basic fabric or Elmotique leather. Plastic feet. Lucky is meant to be monochrome; our selected fabric and leather tones match the chairs precisely. Other fabric choices as quoted after approval from us. CMHR included.

Fabric	Basic	1	2	3	4	Leather
B17 Clear lacquered oak	899			938		1 060
B17 Black stain	899			938		1 060
B17 Red stain	899			938		1 060
B17 Grey stain	899			938		1 060
B17 Green stain	899			938		1 060

Supplement (+)

Stained in customer's choice of NCS colour* or other colours from cc. 4*	31
--	-----------

Surcharge, net (+)

*Set-up cost for painting wood in customer's choice of NCS colour NET/colour	220
--	------------

Recommended fabrics	Basic	1	2	3	4	Leather
	Mainline Flax			Canvas		Elmotique
	Mainline Plus			Rami/Rami Plus		
	Blazer			Steelcut 2		
	Rivet			Steelcut trio 2		
	Patina			Hallingdal		
				All Devina		
				Hero		
				Rime		
				Moor		

Mika Tolvanen 2012

L28 | MIKA

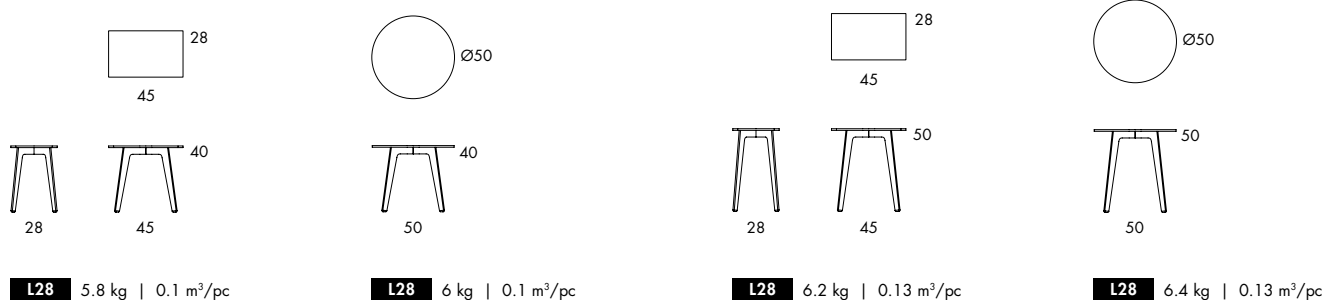

LOW COFFEE TABLE | HIGH COFFEE TABLE. Table in water-cut aluminium for indoor and outdoor use; finished in colour as per cc 2a with fine textured finish. The table also acts as a stool. Table top thickness 10 mm.

Table (cm) Height 40	45x28	Ø50
L28 Black-painted aluminium	734	734
L28 White-painted aluminium	734	734
L28 Polished, lacquered aluminium	773	773

Table (cm) Height 50	45x28	Ø50
L28 Black-painted aluminium	734	734
L28 White-painted aluminium	734	734
L28 Polished, lacquered aluminium	773	773

Other finishes available for projects.

Mia Cullin 2010

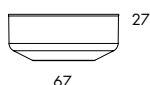
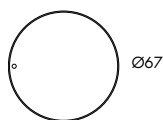
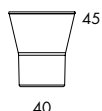
L88, L89 | **MONO****L88** 4.7 kg | 0.13 m²/pc**L89** 5.7 kg | 0.17 m²/pc

HIGH COFFEE TABLE | LOW COFFEE TABLE. Table with stowage in spin-formed aluminium. Clear-lacquered surface or finished as per cc. 2a in smooth gloss paint. Tabletop of laminated/foiled reversible glass or reversible plywood top with an ash veneer or oak veneer surface. Floor protectors in rubber cork.

Tabletop (cm) Height 45 cm	Ø40
------------------------------	-----

L88 Black or white painted aluminium Clear-lacquered oak/ash	461
L88 Black or white painted aluminium Black-stained ash	461
L88 Black or white painted aluminium White painted ash	461
L88 Black or white painted aluminium Glass top black/white	520

L88 Clear lacquered aluminium Clear-lacquered oak/ash	520
L88 Clear lacquered aluminium Black-stained ash	520
L88 Clear lacquered aluminium White painted ash	520
L88 Clear lacquered aluminium Glass top black/white	575

Tabletop (cm) Height 27 cm	Ø66
------------------------------	-----

L89 Black or white painted aluminium Clear-lacquered oak/ash	773
L89 Black or white painted aluminium Black-stained ash	773
L89 Black or white painted aluminium White painted ash	773
L89 Black or white painted aluminium Glass top black/white	869

L89 Clear lacquered aluminium Clear-lacquered oak/ash	869
L89 Clear lacquered aluminium Black-stained ash	869
L89 Clear lacquered aluminium White painted ash	869
L89 Clear lacquered aluminium Glass top black/white	973

Johan Lindau + Borselius & Bernstrand 2015

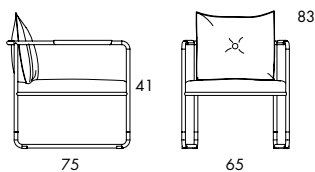
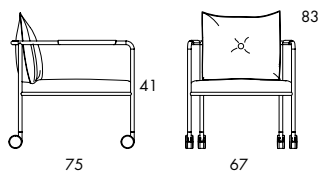
O651, O652 | **MORRIS JR****O651** 13.5 kg | 0.45 m³/pc (1.7 m³/4 pcs)**O652** 14.5 kg | 0.45 m³/pc (1.7 m³/4 pcs)

EASY CHAIR WITH ARMRESTS. Frame with casters or steel runners. Seat with wood and steel frame with no-sag springs. Moulded CMHR foam padding. Frame in chrome-plated (chrome III) or black-painted steel. The seat and back cushion button are always upholstered in leather. Standard leather is Elmodesign Piqué cc. 6c. Back cushion upholstered in selected fabric from list. Armrest upholstered in leather is an option.

Fabric	Xtreme	Basic	1	2	3	4	Leather
O651 Chrome Black leather Frame with casters	1 397	1 414	1 433	1 448	1 466	1 491	1 600
O651 Chrome Brown leather Frame with casters	1 397	1 414	1 433	1 448	1 466	1 491	1 600
O651 Black steel Black leather Frame with casters	1 331	1 347	1 366	1 383	1 398	1 425	1 534
O651 Black steel Brown leather Frame with casters	1 331	1 347	1 366	1 383	1 398	1 425	1 534
O652 Chrome Black leather Leg runners	1 397	1 414	1 433	1 448	1 466	1 491	1 600
O652 Chrome Brown leather Leg runners	1 397	1 414	1 433	1 448	1 466	1 491	1 600
O652 Black steel Black leather Leg runners	1 331	1 347	1 366	1 383	1 398	1 425	1 534
O652 Black steel Brown leather Leg runners	1 331	1 347	1 366	1 383	1 398	1 425	1 534

Surcharge (+)

Armrest upholstered in form felt with black or brown leather cc. 6c	94
---	-----------

Other finishes available for projects.

Stefan Borselius 2009

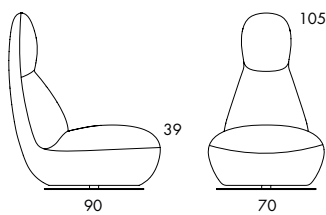
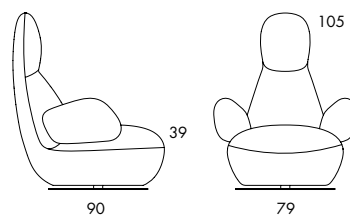
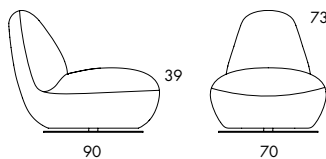
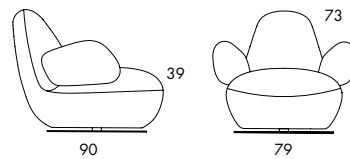
O50, O50A, O52, O52A | **OPPO****O50** 27 kg | 0.9 m³/pc**O50A** 31 kg | 0.9 m³/pc**O52** 26 kg | 0.9 m³/pc**O52A** 30 kg | 0.9 m³/pc

EASY CHAIR. Steel frame with no-sag springs. CMHR moulded polyurethane foam padding with fabric or leather cover. Standard version has a steel swivel base with auto return painted as per cc. 2a in grey textured finish. Alternative chrome-plated steel frame (chrome III).

Fabric	Xtreme	Basic	1	2	3	4	Leather
O50 Grey steel Swivel base with auto return	2 031	2 105	2 153	2 213	2 278	2 347	2 830
O50A Grey steel Swivel base with auto return	2 707	2 793	2 866	2 932	3 008	3 090	3 935
O52 Grey steel Swivel base with auto return	1 983	2 056	2 105	2 164	2 231	2 299	2 783
O52A Grey steel Swivel base with auto return	2 658	2 747	2 818	2 886	2 960	3 043	3 886
O50F Chrome Fixed, tubular steel frame	1 770	1 847	1 891	1 955	2 019	2 086	2 569
O50AF Chrome Fixed, tubular steel frame	2 444	2 533	2 604	2 672	2 747	2 829	3 674
O52F Chrome Fixed, tubular steel frame	1 722	1 799	1 845	1 906	1 970	2 038	2 522
O52AF Chrome Fixed, tubular steel frame	2 399	2 485	2 555	2 624	2 699	2 782	3 627
O50H Chrome Raised tubular steel swivel base +6 cm	2 294	2 367	2 414	2 475	2 539	2 608	3 091
O50AH Chrome Raised tubular steel swivel base +6 cm	2 968	3 055	3 126	3 194	3 269	3 349	4 197
O52H Chrome Raised tubular steel swivel base +6 cm	2 245	2 319	2 366	2 427	2 492	2 560	3 044
O52AH Chrome Raised tubular steel swivel base +6 cm	2 921	3 007	3 079	3 146	3 221	3 304	4 149

Surcharge (+)

Swivel base, prepared for floor mounting	23
--	----

Stefan Borselius 2009

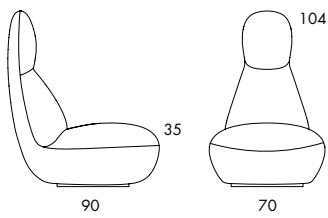
O51L | **OPPOCEMENT****O51L** 450 kg | 0.4 flm**CONCRETE EASY CHAIR.** For outdoor and indoor use.

O51L Blackish grey reinforced concrete	3 233
O51L Natural grey reinforced concrete	3 233
O51L Putty white reinforced concrete	3 233

NOTE! Oppocement is always sold EX WORKS, regardless of any other agreements relating to other products. Shipping quoted separately.

Stefan Borselius 2012

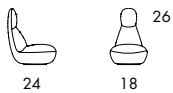
A15 | **MINI-OPPO****A15** 7 kg

MINI-OPPO. Concrete. Can be used as a book end, sculpture; for indoor and outdoor use. Numbered edition.

A15 Blackish grey concrete	263
A15 Natural grey concrete	263
A15 Putty white concrete	263

Stefan Borselius 2008

O43 | PEEKABOO

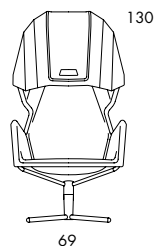
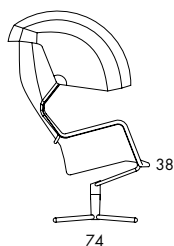
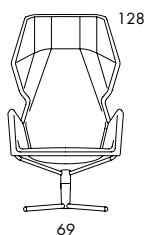
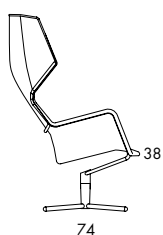
**O43** 10,6 kg | 0,85 m³/pc (1,45 m³/2 pcs)**O43H** 12,6 kg | 0,85 m³/pc (1,45 m³/2 pcs)

SWIVEL CHAIR WITH AUTO-RETURN. Swivel base with auto-return in chrome-plated steel. Seat shell in 100% polyester form felt. The inside of the seat shell is laminated with micro fibre or upholstered in leather. Plastic foot. O43H has a form felt hood with a smoked plexiglass front. Interliner included for D43 seat cushion.

O43 Chrome Anthracite, grey, light grey form felt Inside Waterborn	2 002
--	--------------

O43 Chrome Anthracite, grey, light grey form felt Inside leather, cc. 6a	3 116
--	--------------

O43A Chrome Anthracite, grey, light grey form felt Inside Waterborn* Hood	2 559
---	--------------

O43H Chrome Anthracite, grey, light grey form felt Inside black leather, cc 6a Hood	3 672
---	--------------

Accessories

D43 Upholstered seat cushion Basic fabrics as per list	296
--	------------

D43 Upholstered seat cushion Fabric 1 & 2 as per fabric list	313
--	------------

D43 Upholstered seat cushion Fabric 3 & 4 as per fabric list	338
--	------------

Surcharge (+)

Double-laminated form felt (inside & out) in Waterborn*	398
---	------------

Felt covered plastic foot. Price/chair	3
--	----------

*Waterborn colors: 543, 383, 753, 773, 363, 583, 353, 693, 673, 883, 163, 783, 183, 373, 193, 793, 343, 973

Other finishes available for projects.

Small creases and wrinkles can appear

Johan Lindau 2001

L23 | PING-PONG

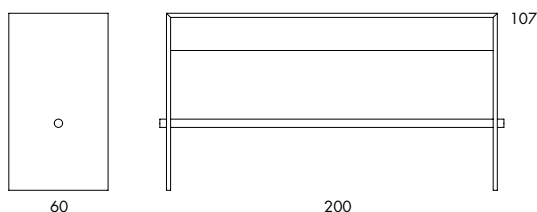

180x60 | 200x60 | 200x70 | 250x80

**L23** 1.5 m²/pc

BAR TABLE. Solid wood, high-pressure laminate on plywood, painted MDF or Valchromat. Stainless steel foot rest. For indoor use.

We customize Ping-Pong bar tables, tables and benches. Other sizes, height, materials and colours are available.

Bar table (cm) Height 107 cm	180x60	200x60	200x70	250x80
L23 Stainless steel White-painted MDF 25 mm	2 308	2 386	2 483	3 117
L23 Stainless steel High-pressure laminate 25 mm	2 777	2 880	3 013	3 831
L23 Stainless steel Black Valchromat 25 mm	2 709	2 808	2 936	3 730
L23 Stainless steel Dark grey Valchromat 25 mm	2 709	2 808	2 936	3 730
L23 Stainless steel Oiled or lacquered solid oak 30 mm	3 538	3 667	3 831	4 841
L23 Stainless steel Clear-lacquered ash 30 mm	3 538	3 667	3 831	4 841
L23 Stainless steel White or black-stained solid ash 30 mm	3 805	3 950	4 134	5 250

Bar table (cm) Height 90 cm	180x60	200x60	200x70	250x80
L23 Stainless steel White-painted MDF 25 mm	2 211	2 288	2 483	2 994
L23 Stainless steel High-pressure laminate 25 mm	2 645	2 747	2 988	3 670
L23 Stainless steel Black Valchromat 25 mm	2 581	2 683	2 911	3 572
L23 Stainless steel Dark grey Valchromat 25 mm	2 581	2 683	2 911	3 572
L23 Stainless steel Oiled or lacquered solid oak 30 mm	3 372	3 502	3 797	4 633
L23 Stainless steel Clear-lacquered ash 30 mm	3 372	3 502	3 797	4 633
L23 Stainless steel White or black-stained solid ash 30 mm	3 620	3 764	3 994	5 017

NOTE! Ping-Pong bar tables, tables and benches are delivered assembled. The customer must ensure that table can be delivered assembled to the specified location.

Johan Lindau 2001

L23 | PING-PONG

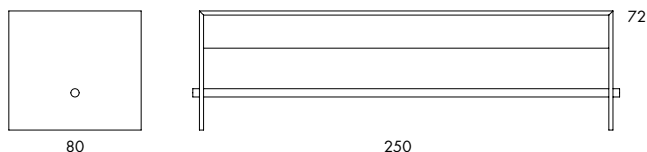
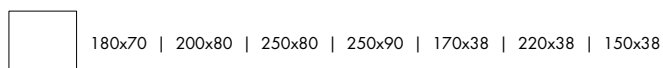

L23

TABLE | BENCH | COFFEE TABLE. Solid wood, high-pressure laminate on plywood, painted MDF or Valchromat. Stainless steel foot rest. For indoor use.

We customize Ping-Pong tables and benches. Other sizes, height, materials and colours are available.

Table (cm) Height 72 cm	180x70	200x80	250x80	250x90
L23 Stainless steel White-painted MDF 25 mm	2 355	2 531	2 848	3 214
L23 Stainless steel High-pressure laminate 25 mm	2 844	3 077	3 470	3 963
L23 Stainless steel Black Valchromat 25 mm	2 772	2 998	3 381	3 855
L23 Stainless steel Dark grey Valchromat 25 mm	2 772	2 998	3 381	3 855
L23 Stainless steel Oiled or lacquered solid oak 30 mm	3 620	3 916	4 384	5 006
L23 Stainless steel Clear-lacquered ash 30 mm	3 620	3 916	4 384	5 006
L23 Stainless steel White or black-stained solid ash 30 mm	3 897	4 227	4 742	5 436

Bench (cm) Seat height 46 cm	150x38	170x38	220x38
L23 Stainless steel White-painted MDF 25 mm	1 605	1 702	1 872
L23 Stainless steel High-pressure laminate 25 mm	1 680	1 858	2 167
L23 Stainless steel Black Valchromat 25 mm	1 648	1 827	2 117
L23 Stainless steel Dark grey Valchromat 25 mm	1 648	1 827	2 117
L23 Stainless steel Oiled or lacquered solid oak 30 mm	2 184	2 394	2 750
L23 Stainless steel Clear-lacquered ash 30 mm	2 184	2 394	2 750
L23 Stainless steel White or black-stained solid ash 30 mm	2 313	2 531	2 911

NOTE! Ping-Pong tables and benches are delivered assembled. The customer must ensure that table can be delivered assembled to the specified location.

Peter Molin 2011

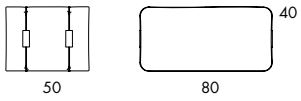
A11 | **PM**

A11 6.5 kg | 0.21 m³/pc (0.91 m³/4 pcs)

STOOL | FOOTSTOOL | HAY BALE. Measures as a hay bale. Polyester foam. Upholstered in fabric or leather. Leather as per colour chart. 6a. Removable, washable cover. Cotton straps. Also available in water-resistant marine fabrics, ask for selection. Interliner included.

Fabric	Xtreme	Basic	1	2	3	4	Leather
A11	726	834	872	920	959	1 020	1 628

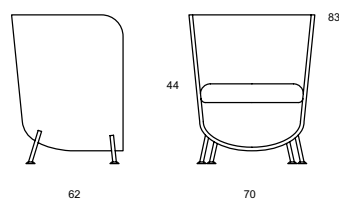

O66 16.5 kg | 1 m³/2 pc

EASY CHAIR. Frame in steel with a core of PurCore. Seat in nosag and PurFlex. Padding of polyether foam. Fully upholstered in fabric or leather. Alternative upholstery with leather interior and fabric exterior. Leather as per colour chart. 6b. Legs in chrome plated (chromium III) or black painted steel.

The various classes of our selected fabrics are shown below. If you choose different shades of the same fabric on the inside and outside, there is a surcharge. If you choose different fabric classes on the inside and outside, the price for the higher fabric class applies. Other fabrics as quoted after approval. CMHR included.

Fabric	Basic	1	2	3	4	Leather
O66 Black steel Fully upholstered	1 285	1 412	1 525	1 615	1 787	2 194
O66L Black steel Leather upholstered inside	1 856	1 921	1 979	2 024	2 111	
O66 Chrome Fully upholstered	1 309	1 436	1 549	1 639	1 811	2 220
O66L Chrome Leather upholstered inside	1 881	1 947	2 003	2 048	2 137	

Surcharge (+)

Inside in contrasting colour	77	105	131	155	188	188
------------------------------	----	-----	-----	-----	-----	-----

Recommended fabrics

	Basic	1	2	3	4	Leather
	Blazer	Aquarius	Tonica	All Divina	Sunniva 2	Elmotique
	Mainline Plus	Hemp	Brink	Steelcut 2	Balder 3	Elmo Soft
	Mainline Flax	Gaja Classic	Silk	Steelcut Trio 2		
		Fame	Breeze Fusion	Hallingdal 65		
		Soft / Mill	Fame Hybrid	Canvas		
		Synergy	Valencia*	Rime		
		Step	Breeze	Rami/Rami Plus		
			Capture	Moor		

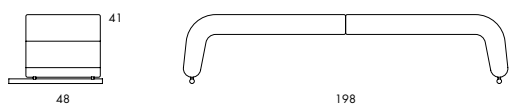
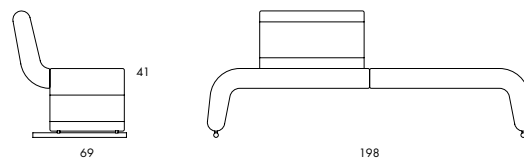
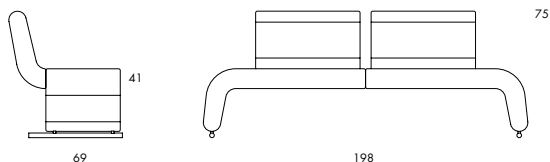
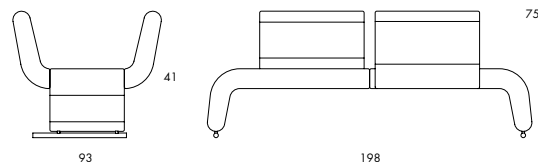
**S20-00** 32 kg | 1.0 m³/pc**S20-01** 38 kg | 1.6 m³/pc**S20-02** 44 kg | 2.0 m³/pc**S20-02** 44 kg | 2.0 m³/pc

BENCH | SOFA. Steel frame. CMHR moulded polyurethane foam padding. Upholstered in fabric or leather. Leather as per cc. 6a. Chrome-plated steel runners (chrome III). Plastic feet.

S20-00 has no backrest, S20-01 has a backrest to the left or right, S20-02 has two backrests next to each other or facing each other.

Fabric	Xtreme	Basic	1	2	3	4	Leather
S20-00 Chrome	2 913	3 021	3 085	3 167	3 260	3 355	4 008
S20-01 Chrome	3 767	3 884	3 958	4 052	4 155	4 259	5 161
S20-02 Chrome	4 639	4 779	4 865	4 975	5 095	5 222	6 312

Surcharge (+)	S20-00	S20-01	S20-02
Edges in contrasting colour/fabric. Per section	225	273	322
Extended rear runner, for location next to a wall	33	33	33

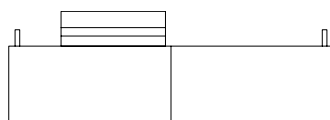
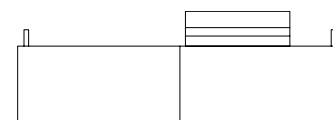
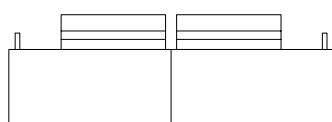
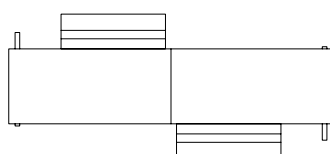
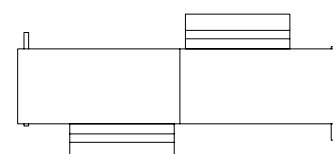
**S20-00****S20-01A****S20-01B****S20-02****S20-02A****S20-02B**

Mia Cullin 2013

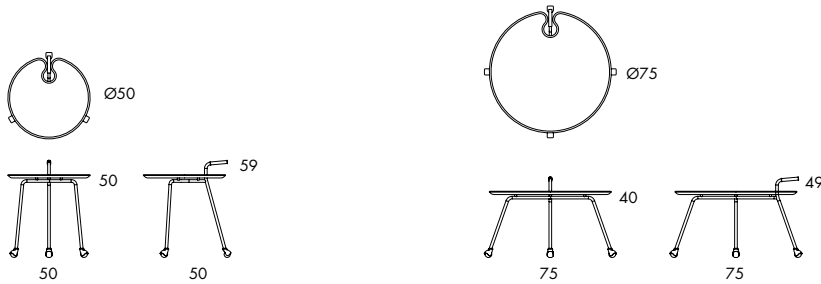
L841, L842 | **POND****L841** 3.95 kg | 0.15 m³/pc**L842** 7.9 kg | 0.3 m³/pc

HIGH COFFEE TABLE | LOW COFFEE TABLE. Solid lacquered ash or oak, chrome-plated frame (chrome III) or painted steel according to cc. 2a fine textured finish. Casters Handle covered in black rubber or leather according to cc. 5. Pond L842 has 4 legs, Pond L841 has 3 legs.

Table height 50 cm 3 legs	Ø50
L841 Chrome Clear-lacquered ash Black rubber handle	645
L841 Chrome Clear-lacquered ash Black or natural leather handle	809
L841 Chrome White or black-stained ash Black rubber handle	680
L841 Chrome White or black-stained ash Black or natural leather handle	844
L841 Chrome Clear-lacquered oak Black rubber handle	680
L841 Chrome Clear-lacquered oak Black or natural leather handle	844

Table height 40 cm 4 legs	Ø75
L842 Chrome Clear-lacquered ash Black rubber handle	958
L842 Chrome Clear-lacquered ash Black or natural leather handle	1 128
L842 Chrome White or black-stained ash Black rubber handle	1 002
L842 Chrome White or black-stained ash Black or natural leather handle	1 164
L842 Chrome Clear-lacquered oak Black rubber handle	1 002
L842 Chrome Clear-lacquered oak Black or natural leather handle	1 164

Surcharge (+)

Table legs lacquered black as per cc. 2a fine textured finish*	23
--	-----------

Surcharge, net (+)

*Set-up charge for steel as per cc. 2a . NET/colour	220
---	------------

Stefan Borselius + Bernstrand & Lindau 2015/2016

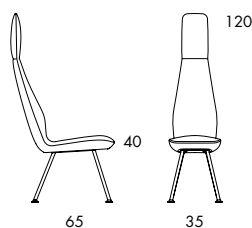
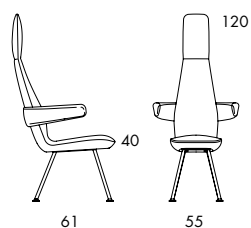
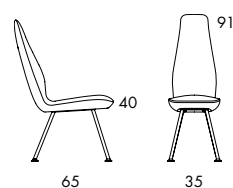
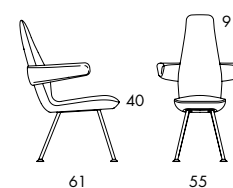
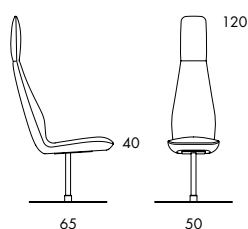
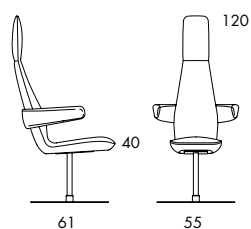
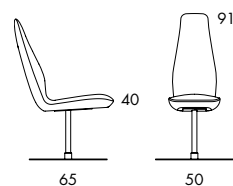
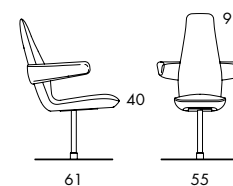
O151, O152 | **POPPE****O151H** 8.2 kg | 0.48 m³**O151HA** 10.4 kg | 0.48 m³**O151L** 7.7 kg | 0.36 m³**O151LA** 9.9 kg | 0.36 m³**O152H** 15.3 kg | 0.48 m³**O152HA** 17.5 kg | 0.48 m³**O152L** 14.8 kg | 0.36 m³**O152LA** 17 kg | 0.36 m³

EASY CHAIR. Seat height 40 cm. Steel frame. CMHR moulded polyurethane foam padding. Upholstered in fabric or leather. Leather as per cc. 6a. Frame O151 in chrome-plated (chrome III) or black-painted steel. Swivel base O152 in polished satin chrome (chrome III). Poppe chair with seat height 46 cm, see next page.

Fabric	Xtreme	Basic	1	2	3	4	Leather
O151H Black steel Leg frame	843	867	893	917	942	976	1 217
O151HA Black steel Leg frame Armrest	1 232	1 270	1 312	1 350	1 389	1 446	1 839
O151L Black steel Leg frame	818	842	868	892	917	951	1 192
O151LA Black steel Leg frame Armrest	1 206	1 245	1 289	1 325	1 364	1 420	1 812
O151H Chrome Leg frame	857	881	906	929	954	987	1 231
O151HA Chrome Leg frame Armrest	1 245	1 282	1 326	1 362	1 403	1 457	1 851
O151L Chrome Leg frame	832	856	882	904	929	964	1 204
O151LA Chrome Leg frame Armrest	1 220	1 257	1 301	1 339	1 378	1 432	1 828
O151H Painted steel as per cc. 2b* Leg frame	857	881	906	929	954	987	1 231
O151HA Painted steel as per cc. 2b* Leg frame Armrest	1 245	1 282	1 326	1 362	1 403	1 457	1 851
O151L Painted steel as per cc. 2b* Leg frame	832	856	882	904	929	964	1 204
O151LA Painted steel as per cc. 2b* Leg frame Armrest	1 220	1 257	1 301	1 339	1 378	1 432	1 828
O152H Polished satin chrome Swivel base	1 062	1 087	1 112	1 136	1 161	1 195	1 437
O152HA Polished satin chrome Swivel base Armrest	1 451	1 490	1 531	1 568	1 609	1 665	2 059
O152L Polished satin chrome Swivel base	1 037	1 062	1 087	1 111	1 136	1 170	1 412
O152LA Polished satin chrome Swivel base Armrest	1 425	1 465	1 507	1 543	1 582	1 639	2 032

Surcharge, net (+)

* Set-up charge for frame O151 as per cc. 2b. NET/colour	220
* Set-up charge for frame O151 for custom RAL colour. NET/colour	650

Stefan Borselius + Bernstrand & Lindau 2015/2016

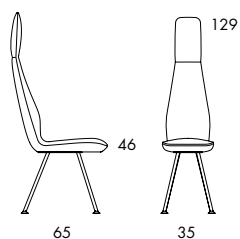
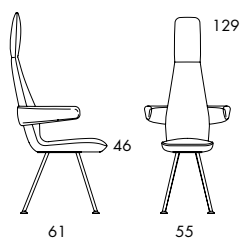
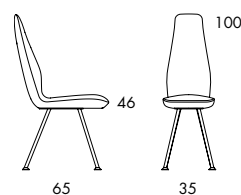
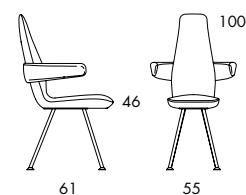
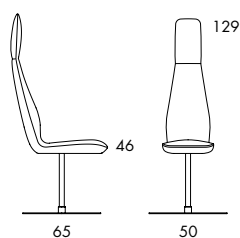
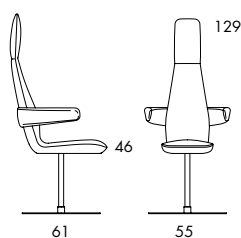
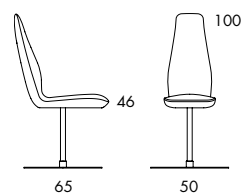
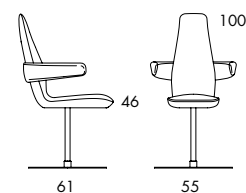
O161, O162 | **POPPE****O161H** 8.3 kg | 0.5 m³**O161HA** 10.5 kg | 0.5 m³**O161L** 7.8 kg | 0.39 m³**O161LA** 10 kg | 0.39 m³**O162H** 15.4 kg | 0.5 m³**O162HA** 17.6 kg | 0.5 m³**O162L** 14.9 kg | 0.39 m³**O162LA** 17.1 kg | 0.39 m³

CHAIR. Seat height 46 cm. Steel frame. CMHR moulded polyurethane foam padding. Upholstered in fabric or leather. Leather as per cc. 6a. Frame O151 in chrome-plated (chrome III) or black-painted steel. Swivel base O152 in polished satin chrome (chrome III). Poppe easy-chair with seat height 40 cm, see previous page.

Fabric	Xtreme	Basic	1	2	3	4	Leather
O161H Black steel Leg frame	843	867	893	917	942	976	1 217
O161HA Black steel Leg frame Armrest	1 232	1 247	1 289	1 327	1 366	1 423	1 816
O161L Black steel Leg frame	818	819	845	869	894	928	1 169
O161LA Black steel Leg frame Armrest	1 206	1 222	1 266	1 302	1 341	1 397	1 789
O161H Chrome Leg frame	857	858	883	906	931	964	1 208
O161HA Chrome Leg frame Armrest	1 245	1 259	1 303	1 339	1 380	1 434	1 828
O161L Chrome Leg frame	832	833	859	881	906	941	1 181
O161LA Chrome Leg frame Armrest	1 220	1 234	1 278	1 316	1 355	1 409	1 805
O161H Painted steel as per cc. 2b* Leg frame	857	858	883	906	931	964	1 208
O161HA Painted steel as per cc. 2b* Leg frame Armrest	1 245	1 259	1 303	1 339	1 380	1 434	1 828
O161L Painted steel as per cc. 2b* Leg frame	832	833	859	881	906	941	1 181
O161LA Painted steel as per cc. 2b* Leg frame Armrest	1 220	1 234	1 278	1 316	1 355	1 409	1 805
O162H Polished satin chrome Swivel base	1 062	1 087	1 112	1 136	1 161	1 195	1 437
O162HA Polished satin chrome Swivel base Armrest	1 451	1 490	1 531	1 568	1 609	1 665	2 059
O162L Polished satin chrome Swivel base	1 037	1 062	1 087	1 111	1 136	1 170	1 412
O162LA Polished satin chrome Swivel base Armrest	1 425	1 465	1 507	1 543	1 582	1 639	2 032

Surcharge, net (+)

* Set-up charge for frame O151 as per cc. 2b. NET/colour	220
* Set-up charge for frame O151 for custom RAL colour. NET/colour	650

Stefan Borselius 2016

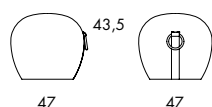
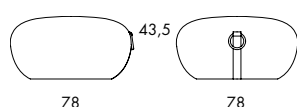
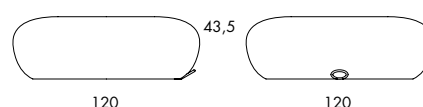
O541, O542, O543 | **PUCCA****O541** 5.3 kg | 0.13 m³/pc**O542** 7.6 kg | 0.5 m³/pc (0.91 m³/2 pcs)**O543** 17 kg | 0.86 m³/pc (1.44 m³/2 pcs)

POUF. Frame of wood. Padding in CMHR polyurethane foam. Upholstered in fabric or leather. Leather as per cc. 6a. Ring in stainless steel. Grey polyester strap. Plastic feet.

Fabric	Mainline Flax	Basic	1	2	3	4	Leather
O541	623	642	664	681	701	729	882
O542	1 028	1 070	1 117	1 156	1 200	1 261	1 742
O543	1 524	1 588	1 658	1 722	1 789	1 885	

Steel fitting ready for floor bracket available for projects. Polyester straps and stainless steel ring available in other colors for projects.

Recommended fabrics	Xtreme	Basic	1	2	3	4	Leather
*Pucca covered in vinyl/artificial leather may develop small creases along the seams.	X2	Aquarius	Crisp	Divina 3	Sunniva 2	Elmo Soft	
	Blazer	Hemp	Luna 2	Divina Melange	Balder 3		
	Mainline Plus	Europost 2	Tonus 4	Divina MD	Outback		
	Mainline Flax	Gaja Classic	Tonus Meadow	Steelcut 2			
	Step	Fame	Tonica	Steelcut Trio 2			
	Step melange	Remix 2	Clara 2	Hallingdal 65			
		Flex	Memory	Canvas			
		Soft	Brink	Rime			
		Synergy	Silk	Rami			
		Shimmer	Breeze Fusion	Rami Plus			
		Step	Fame Hybrid	Stamskin Top*			
			Valencia*	Moor			
			Silvertext*	Fiord			
			Breeze	Molly 2			
			Capture				
			Rock				
			Bowen				

Stefan Borselius 2010

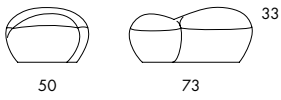
O53 | **PUPPA****O53** 4.8 kg | 0.15 m³/pc

FOOTSTOOL. Frame of wood. Padding in CMHR moulded polyurethane foam. Upholstered in fabric or leather. Leather as per cc. 6a. Plastic feet.

Puppa is part of the Oppo family.

Fabric	Xtreme	Basic	1	2	3	4	Leather
O53	718	743	787	826	865	915	1 140

Steel fittings ready for floor mountings available for projects.

Börge Lindau 1999, Lindau & Lindekrantz 1965

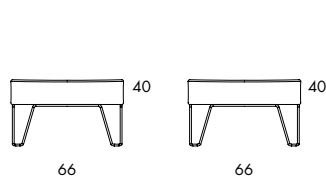
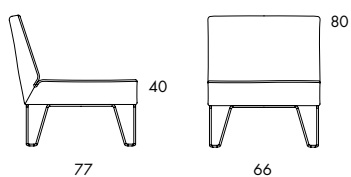
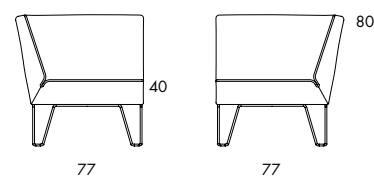
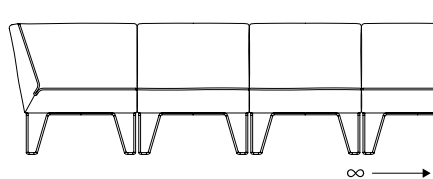
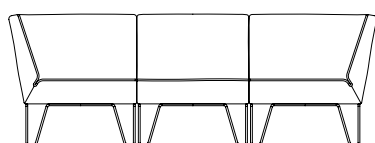
S10 | **QVARTO****S100** 11 kg | 0.18 m³/pc**S102** 17 kg | 0.45 m³/pc**S103** 23.5 kg | 0.53 m³/pc

SECTIONAL SOFA. Frame of wood. Padding of CMHR polyurethane foam. No-sag springs. Upholstered in fabric or leather. Leather as per cc. 6a. Chrome-plated steel frame (chrome III). Plastic foot. Link fitting

Fabric	Xtreme	Basic	1	2	3	4	Leather
S100 Chrome Footstool	981	1 034	1 073	1 109	1 141	1 181	1 855
S102 Chrome Centre	1 306	1 377	1 445	1 497	1 550	1 602	2 272
S103 Chrome Corner	1 711	1 809	1 920	2 002	2 083	2 144	3 175
S100 Black Footstool	1 008	1 059	1 102	1 136	1 167	1 209	1 880
S102 Black Centre	1 331	1 400	1 470	1 523	1 575	1 627	2 300
S103 Black Corner	1 736	1 834	1 945	2 028	2 108	2 167	3 203

Surcharge (+)

Wooden frame in solid clear-lacquered ash or birch	300
Wooden frame in solid clear-lacquered or oiled oak	306
Wooden frame in solid black or white-stained ash.	306

Surcharge, net (+)

*Set-up charge for frame in custom RAL colour NET/colour	650
--	-----

Thomas Bernstrand 2013

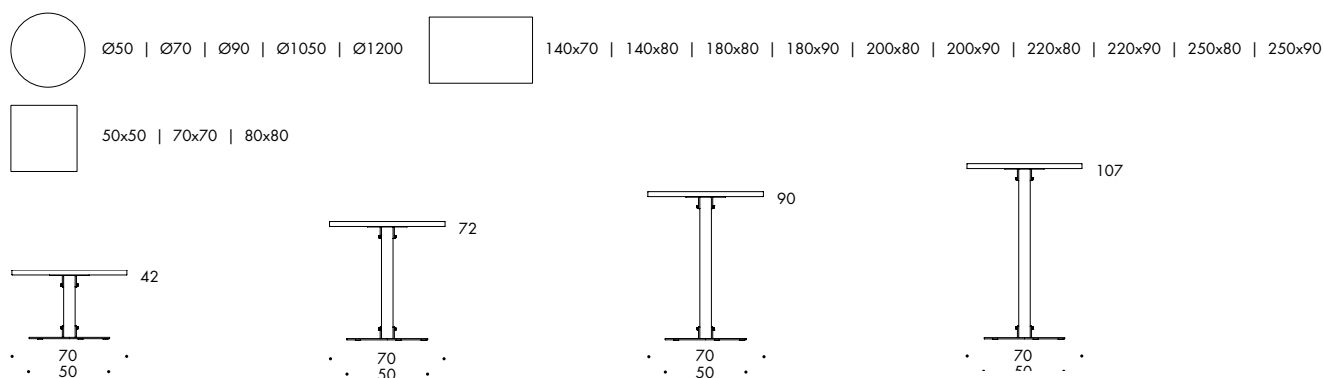
L901 | **SIZE****L901**

PEDESTAL TABLE. Solid lacquered ash or oak, stained or oiled finish. Chrome plated steel fittings and footplate (chrome III). Chrome plated bolts. The rectangular tables have two frames. Footplates have standard diameters of 50 or 60 cm. As its name suggests, Size can be supplied in many sizes. Illustrations are for example only. Custom sizes available. Tabletop thickness 3 cm.

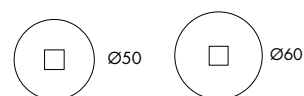

Bar top (cm) Height 42 or 72 cm	Ø50	Ø70	Ø90	Ø1050	Ø1200	50x50	70x70	80x80
L901 Chrome Clear-lacquered or oiled oak	1 555	1 686	1 867	2 166	2 345	1 555	1 686	1 845
L901 Chrome Clear-lacquered ash	1 555	1 686	1 867	2 166	2 345	1 555	1 686	1 845
L901 Chrome Black or white-stained ash	1 627	1 759	1 948	2 303	2 491	1 627	1 759	1 938
L901 Chrome Ash, Custom stained in NCS colour*	1 627	1 759	1 948	2 303	2 491	1 627	1 759	1 938

Bar top (cm) Height 42 or 72 cm	140x70	140x80	180x80	180x90	200x90	220x90	250x90
L901 Chrome Clear-lacquered or oiled oak	2 777	2 852	3 098	3 191	3 486	3 552	3 677
L901 Chrome Clear-lacquered ash	2 777	2 852	3 098	3 191	3 486	3 552	3 677
L901 Chrome Black or white-stained ash	2 869	2 952	3 225	3 330	3 631	3 716	3 847
L901 Chrome Ash, Custom stained in NCS colour*	2 869	2 952	3 225	3 330	3 631	3 716	3 847

Bar top (cm) Height 90 or 107 cm	Ø50	Ø70	Ø90	Ø1050	50x50	70x70
L901 Chrome Clear-lacquered or oiled oak	1 658	1 788	1 970	2 259	1 658	1 788
L901 Chrome Clear-lacquered ash	1 658	1 788	1 970	2 259	1 658	1 788
L901 Chrome Black or white-stained ash	1 731	1 864	2 069	2 305	1 731	1 864
L901 Chrome Ash, Custom stained in NCS colour*	1 731	1 864	2 069	2 305	1 731	1 864

Bar top (cm) Height 90 or 107 cm	140x70	140x80	180x80	180x90	200x80	220x80	250x80
L901 Chrome Clear-lacquered or oiled oak	2 983	3 059	3 305	3 483	3 670	3 738	3 859
L901 Chrome Clear-lacquered ash	2 983	3 059	3 305	3 483	3 670	3 738	3 859
L901 Chrome Black or white-stained ash	3 131	3 198	3 472	3 575	3 856	3 878	4 070
L901 Chrome Ash, Custom stained in NCS colour*	3 131	3 198	3 472	3 575	3 856	3 878	4 070

Surcharge, net (+)

*Set-up charge for stain in custom NCS colour. NET/colour	220
*Set-up charge for footplate and fittings in custom RAL colour.	650
*Set-up charge for steel finished as per cc. 2a fine textured finish	220

Thomas Bernstrand 2013

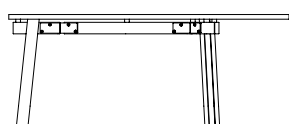
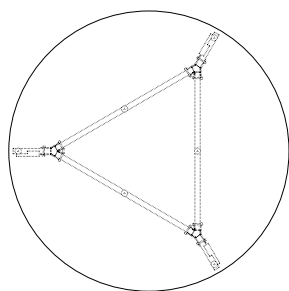
L903 | **SIZE**

180

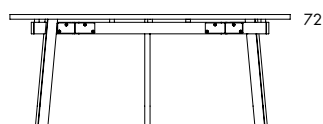

180

72

L903

TABLE WITH 3-LEGGED FRAME. For round tabletops with edging beneath the top. Solid lacquered ash or oak, stained or oiled finish. Chrome-plated steel fittings (chrome III). As its name suggests, Size can be supplied in many sizes. Illustrations are for example only. Custom sizes available. Tabletop thickness 3 cm

Coffee table (cm) Height 42 cm	Ø140	Ø180
L903 Clear-lacquered or oiled oak	3 444	3 913
L903 Clear-lacquered ash	3 444	3 913
L903 Black or white-stained ash	3 656	4 122
L903 Ash, Custom stained in NCS colour*	3 656	4 122

Table (cm) Height 72 cm	Ø140	Ø180
Recommended seating	6	9
L903 Clear-lacquered or oiled oak	3 478	3 933
L903 Clear-lacquered ash	3 478	3 933
L903 Black or white-stained ash	3 681	4 144
L903 Ash, custom stained in NCS colour*	3 681	4 144

Surcharge, net (+)

*Set-up charge for stain in custom NCS colour. NET/colour	220
---	------------

Thomas Bernstrand 2013

L904 | **SIZE****L904**

TABLE WITH 4-LEGGED FRAME. For round or square tabletops with edging beneath the top. Solid lacquered ash or oak, stained or oiled finish. Chrome-plated steel fittings (chrome III). As its name suggests, Size can be supplied in many sizes. Illustrations are for example only. Custom sizes available. Tabletop thickness 3 cm

Coffee table (cm) Height 42 cm	Ø170	130x130
L904 Clear-lacquered or oiled oak	3 966	3 511
L904 Clear-lacquered ash	3 966	3 511
L904 Black or white-stained ash	4 169	3 720
L904 Ash, Custom stained in NCS colour*	4 169	3 720

Table (cm) Height 72 cm	Ø120	Ø170	130x130
Recommended seating	4	8	8
L904 Clear-lacquered or oiled oak	3 050	3 050	3 989
L904 Clear-lacquered ash	3 050	3 050	3 989
L904 Black or white-stained ash	3 131	3 131	4 200
L904 Ash, custom stained in NCS colour*	3 131	3 131	4 200

Surcharge, net (+)

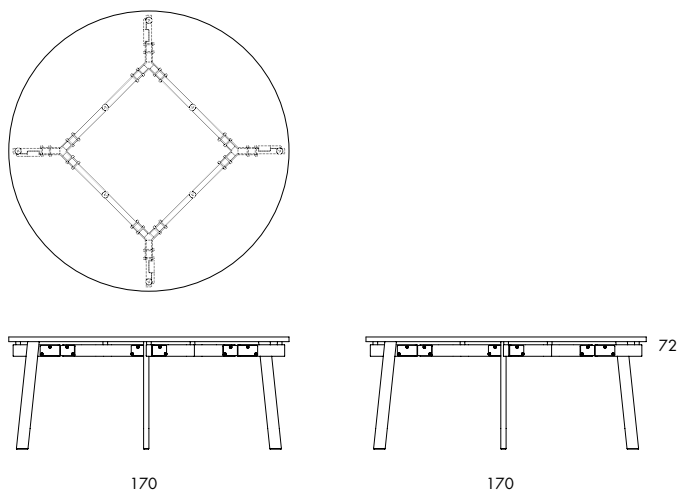
*Set-up charge for stain in custom NCS colour. NET/colour	220
---	------------

Thomas Bernstrand 2013

L905 | **SIZE**

TABLE WITH 4-LEGGED FRAME. For rectangular tabletops with longitudinal beams beneath the top. Solid lacquered ash or oak, stained or oiled finish. Chrome plated steel fittings (chrome III). As its name suggests, Size can be supplied in many sizes. Illustrations are for example only. Custom sizes available. Tabletop thickness 3 cm



Coffee table (cm) Height 42 cm	120x70	140x70	140x80	180x80	180x90	200x70	200x90	200x100
L905 Clear-lacquered or oiled oak	2 373	2 484	2 683	2 777	2 880	2 916	3 133	3 233
L905 Clear-lacquered ash	2 373	2 484	2 683	2 777	2 880	2 916	3 133	3 233
L905 Black or white-stained ash	2 463	2 575	2 778	2 891	3 008	3 078	3 273	3 391
L905 Ash, Custom stained in NCS colour*	2 463	2 575	2 778	2 891	3 008	3 078	3 273	3 391

Table (cm) Height 72 cm	120x70	140x70	140x80	180x80	180x90	200x70	200x90	200x100
L905 Clear-lacquered or oiled oak	2 398	2 508	2 706	2 800	2 903	2 948	3 158	3 256
L905 Clear-lacquered ash	2 398	2 508	2 706	2 800	2 903	2 948	3 158	3 256
L905 Black or white-stained ash	2 484	2 597	2 803	2 916	3 033	3 103	3 300	3 416
L905 Ash, Custom stained in NCS colour*	2 484	2 597	2 803	2 916	3 033	3 103	3 300	3 416

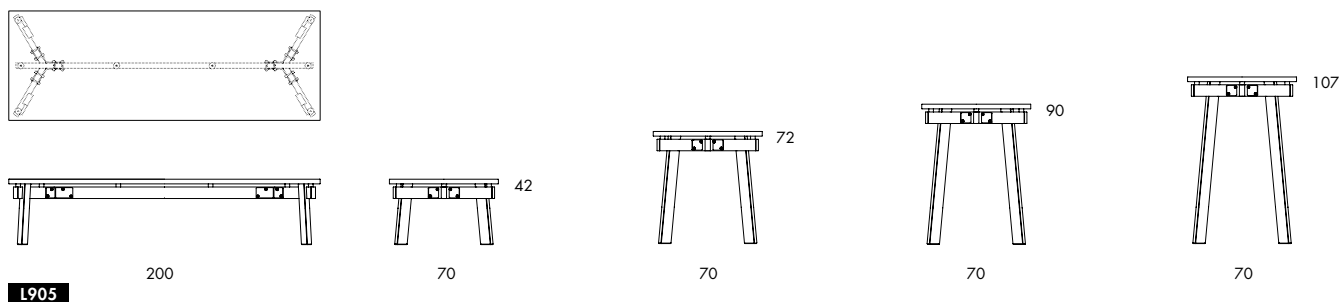
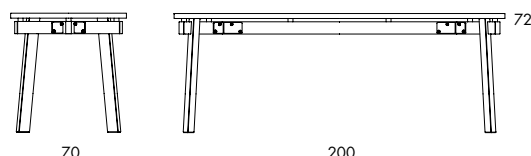
Table (cm) Height 72 cm	220x90	220x100	250x90	250x100	300x90	300x100	330x90	330x100
L905 Clear-lacquered or oiled oak	3 623	3 720	3 750	3 870	3 970	4 106	4 106	4 223
L905 Clear-lacquered ash	3 623	3 720	3 750	3 870	3 970	4 106		
L905 Black or white-stained ash	3 777	3 891	3 923	4 059	4 173	4 328		
L905 Black-stained oak							4 331	4 473
L905 Ash, Custom stained in NCS colour*	3 777	3 891	3 923	4 059	4 173	4 328		

Bar table (cm) Height 90 or 107 cm	120x70	140x70	140x80	180x80	180x90	200x70	200x90	200x100
L905 Clear-lacquered or oiled oak	2 434	2 545	2 744	2 838	2 944	2 986	3 195	3 294
L905 Clear-lacquered ash	2 434	2 545	2 744	2 838	2 944	2 986	3 195	3 294
L905 Black or white-stained ash	2 533	2 644	2 850	2 963	3 078	3 144	3 345	3 452
L905 Ash, Custom stained in NCS colour*	2 533	2 644	2 850	2 963	3 078	3 144	3 345	3 452

Surcharge, net (+)

* Set-up charge for stain in custom NCS colour. NET/colour **220**

Electrical accessories/Data

Cutout, cable hole	145
D901 Wiring, tabletop, no cap. Fitting. 691028. Silver 282x92mm. 2 elec, 2 mains Cat6, 1 HDMI, 1 VGA, 1 audio, 1 USB	248
D901UK Wiring, tabletop, no cap. Fitting. 691028-UK. Silver 282x92mm 2 elec, 2 mains Cat6, 1 HDMI, 1 VGA, 1 audio, 1 USB	258
D903 Box Bi-Lid with twin openings. 721200. Silver. 300x150mm. (No fittings)	178
D904 Fitting Power Inlay for Bi-Lid. 721003. 2 elec, 1 mains Cat6, 1 VGA, 1 audio, 1 USB	166

Börge Lindau 1993

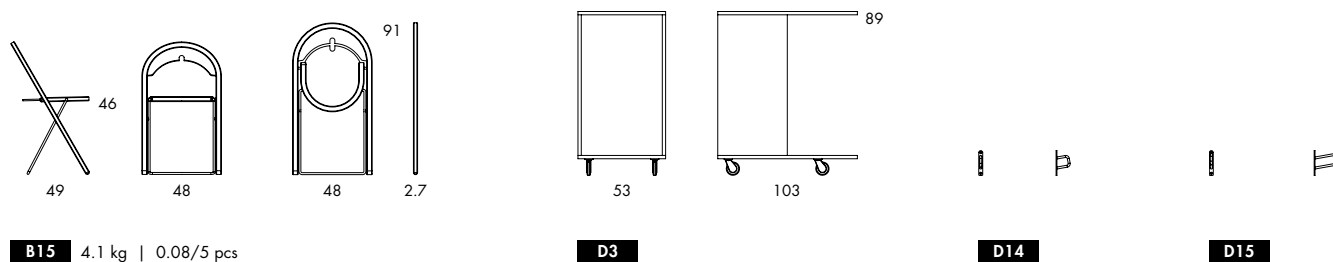
B15 | **SPARTA****B15** 4.1 kg | 0.08/5 pcs**D3****D14****D15**

FOLDING CHAIR. Back and seat arc in compression moulded, layer-glued, clear-lacquered birch veneer. Seat and back in lacquered birch. Legs in chrome-plated (chrome III) or black-painted steel.

B15 Black steel Clear-lacquered birch	328
B15 Black steel Clear lacquered birch Seat and back panel finished as per cc. 4	356
B15 Black steel Full paint finish as per cc. 4	383
B15 Chrome Clear-lacquered birch	345
B15 Chromium Clear lacquered birch Seat and back panel finished as per cc. 4	375
B15 Chrome Full paint finish as per cc. 4	400

Accessories

D14 Steel wall hook for 2 pcs B15 Black or chrome	23
D15 Steel wall hook for 5 pcs B15 Black or chrome	23
D17 Steel link fitting Grey paint finish	23
D16 Steel floor stand for 10 pcs B15 Chrome Linkable	366
D3 Trolley for 26 pcs B15 lying flat Clear lacquered birch	853





Surcharge (+)

Finished in custom NCS colour** Min. 8 pcs/colour	56
---	-----------

Surcharge, net (+)

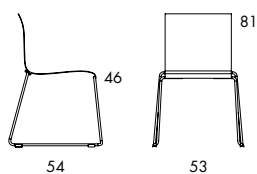
Set-up charge for custom NCS colour NET/colour	220
--	------------

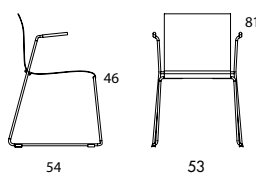
Stefan Borselius & Fredrik Mattson 2003

O30, O30A | **STING**
O30 6 kg | 0.29 m³/4 pcs (1.13 m³/28 pcs) 

O30A 7 kg | 0.29 m³/4 pcs (1.13 m³/28 pcs) 

STACKABLE, LINKABLE CHAIR | ARMCHAIR. Legs in stainless steel. Seat and back in extruded aluminium. Plastic foot. O30A has stainless steel arms; black polyurethane arm pads. Chair for indoor and outdoor use.

Seat cushions available as options. Seat cushion in moulded polyurethane for indoor and outdoor use. Seat cushions in Comfort for indoor use. Seat and back covered in Tärnsjö leather as per cc. 5. The Sting family also includes the Gecco barstool and Level table.

O30 Stainless steel Natural aluminium	680
O30 Stainless steel Leather-covered seat and back	1 098
O30A Stainless steel Natural aluminium	766
O30A Stainless steel Leather-covered seat and back	1 191

Accessories

D30 All-in-one seat/back cushion, black or anthracite moulded polyester	95
D31 Whole cushion seat/back Black Comfort	127
D33 Cushion for seat only Black Comfort	72
DOT Individual cushion Ø350 mm in felt Anti-glide back cc. DOT	41
D32 Link fittings Black plastic. Price/item SEK	8
D36 Trolley Galvanized steel For 50 chairs O30 or O30A	756
D35 Writing surface for O30. Painted steel top Black Stainless steel arm (right)	169

Surcharge (+)

D82 Felt covered plastic foot/chair	9
-------------------------------------	----------

Sting O30 in lightweight (4.5 kg) available for projects.

Other RAL colours available for projects. Please ask.

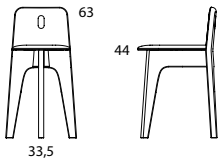
**O64** 4,1 kg

STOOL. Solid ash wood in clear-lacquered or lacquered finish. Wall hook in clear-lacquered ash is included, one/stool

Wooden stool	Ash	Black	Green
O64 Stool	305	305	305

Surcharge (+)

D81 Plastic feet	16		
------------------	----	--	--

Accessories

D1 Wall hook Black- or clearlacquered solid ash for 1 pcs O64	23	27	
D3 Wall rack Black- or clearlacquered solid ash for 3 pcs O64	217	242	

For customized colours ask us. A minimi quantity is required.

Osko + Deichmann 2010

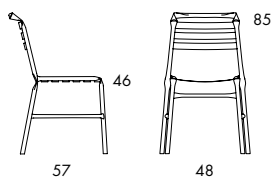
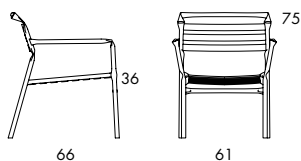
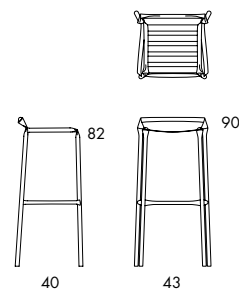
O35, O36, O37 | **STRAW**
O35 5.9 kg | 0.36 m³/2 pcs

O36 8.2 kg | 0.45 m³/2 pcs

O37 5.8 kg | 0.24 m³

STACKABLE CHAIR | STACKABLE LOUNGE CHAIR | STACKABLE BAR-STOOL. Galvanised and lacquered "kinked" tubular steel. Plastic feet. For indoor and outdoor use.

O35 Black or white steel cc. 2a Fine textured finish	339
--	------------

O35 Painted steel as per cc. 2b Smooth matte finish	375
---	------------

O35 Painted steel in custom RAL colour*. Min. 8 pcs/colour	383
--	------------

O36 Black or white steel cc. 2a Fine textured finish	500
--	------------

O36 Painted steel as per cc. 2b Smooth matte finish	536
---	------------

O36 Painted steel in custom RAL colour*. Min. 8 pcs/colour	545
--	------------

O37 Black or white steel cc. 2a Fine textured finish	339
--	------------

O37 Painted steel as per cc. 2b Smooth matte finish	375
---	------------

O37 Painted steel in custom RAL colour*. Min. 8 pcs/colour	383
--	------------

Accessories

DO35 Anthracite grey seat cushion in Dartex** Removable	81
---	-----------

DO36 Anthracite grey seat cushion in Dartex** Removable	98
---	-----------

DO37 Anthracite grey seat cushion in Dartex** Removable	73
---	-----------

Surcharge, net (+)

*Set-up charge for steel in custom RAL colour. NET/colour	650
---	------------

**Dartex is a waterproof, polyurethane-based textile.

Osko + Deichmann 2015 - 2017

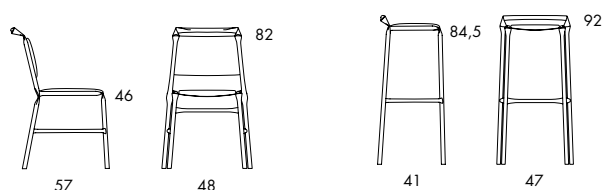
S25 | **SUPERSTRAW****S25N** 6.15 kg **S24-82** 5.5 kg 

STACKABLE CHAIR & BARSTOOL. Kinked painted tubular steel frame. CMHR polyurethane padding in seat and back. Upholstered in fabric or leather. Leather as per colour chart. 6a. Plastic foot. For indoor use.

Fabric	Xtreme	Basic	1	2	3	4	Leather
S25N Black steel Fine textured finish	527	539	550	563	575	592	617
S25N Painted steel as per cc. 2b Fine textured finish	527	539	550	563	575	592	617
S25N Painted steel in custom RAL colour*.	542	555	566	578	591	608	633
S24-65 Black steel Fine textured finish	439	455	467	481	502	513	509
S24-65 Painted steel as per cc. 2b Fine textured finish	439	455	467	481	502	513	509
S24-65 Painted steel in custom RAL colour*.	470	486	498	513	533	544	541
S24-82 Black steel Fine textured finish	459	475	491	502	522	534	534
S24-82 Painted steel as per cc. 2b Fine textured finish	459	475	491	502	522	534	534
S24-82 Painted steel in custom RAL colour*.	477	494	506	522	539	553	553

Surcharge, net (+)

*Set-up charge for steel in custom RAL colour. NET/colour	650
---	-----

Osko + Deichmann 2013

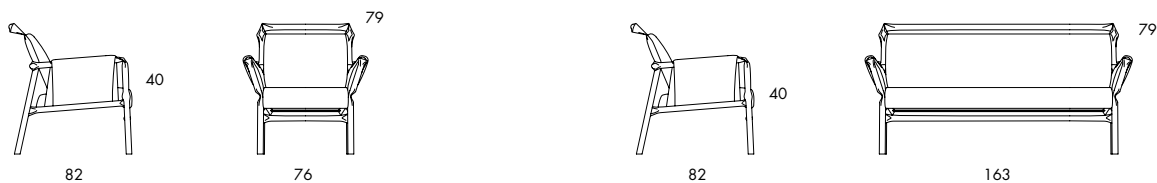
S26, S27 | **SUPERKINK****S26** 19 kg | 0.45 m³/pc**S27** 40 kg | 1.2 m³/pc

EASY CHAIR | SOFA. Kinked tubular steel frame finished in matte black. Wooden frame. Padding of CMHR polyurethane foam. Upholstered in fabric or leather. Leather as per cc. Óa. Plastic foot. For indoor use.

Fabric	Xtreme	Basic	1	2	3	4	Leather
S26 Black steel as per cc. 2a Fine textured finish	1 953	2 061	2 134	2 205	2 295	2 366	3 545
S26 Painted steel as per cc. 2b Smooth matte finish	1 989	2 097	2 167	2 241	2 328	2 400	3 581
S26 Painted steel in custom RAL colour* .	1 997	2 105	2 177	2 250	2 339	2 411	3 589
S27 Black steel as per cc. 2a Fine textured finish	2 850	3 013	3 102	3 209	3 352	3 461	5 139
S27 Painted steel as per cc. 2b Smooth matte finish	2 884	3 047	3 136	3 244	3 386	3 494	5 173
S27 Painted steel in custom RAL colour* .	2 894	3 055	3 145	3 253	3 395	3 503	5 183

Surcharge, net (+)

*Set-up charge for steel in custom RAL colour. NET/colour	650
---	------------

Annette Petersson & Lotta Josefsson 1996

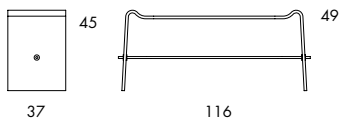
O62 | **SÖNDAG****O62** 10.5 kg | 0.3 m³/pc

BENCH. Compression moulded, layer-glued lacquered birch. Brace in chrome-plated (chrome III) or black-painted steel.

There are options such as polyester padded seats upholstered in fabric or leather. Leather as per cc. 6a.

O62 Chrome or black steel Clear-lacquered birch	773
O62 Chrome or black steel White lacquered birch	850
O62 Chrome or black steel Stained as per cc. 4	834

Surcharge (+)	Xtreme	Basic	1	2	3	4	Leather
D62 Padded seat	158	170	209	209	236	236	438

Tomoyuki Matsuoka 2016

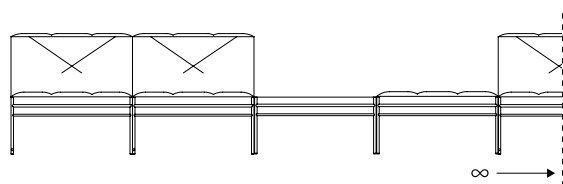
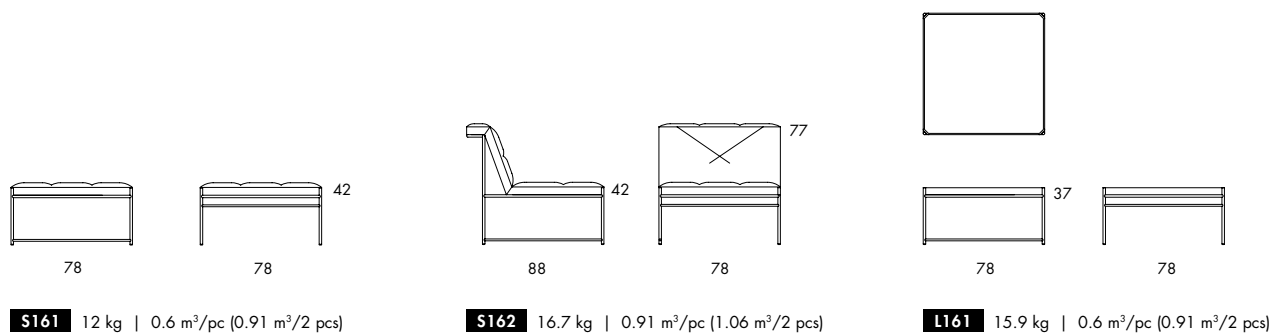
S161, S162, L161 | **UNIT**

SECTIONAL FURNITURE. Frame of wood. Padding of CMHR polyurethane foam. No-sag springs. Upholstered in fabric or leather. Leather as per cc. 6a. Painted steel frame. Plastic foot. Link fitting. Tabletop in solid wood.

Fabric	Xtreme	Basic	1	2	3	4	Leather
S161 Black Footstool	989	1 028	1 069	1 106	1 145	1 200	1 331
S162 Black Easy chair	1 431	1 477	1 523	1 567	1 613	1 677	2 108

L161 Black Clear lacquered or oiled oak Table	978
L161 Black Clear lacquered or oiled oak Table	978
L161 Black Black lacquered oak Table	1 044

Surcharge (+)

Frame lacquered as per cc. 2b*. Min. 8 pcs/colour	23
Frame in custom RAL colour**. Min. 8 pcs/colour	23

Surcharge, net (+)

* Set-up charge for steel as per cc. 2b. NET/colour	220
** Set-up charge for frame in custom RAL colour. NET/colour	650

When selecting vinyl, only Skai Parotega or Spradling Valencia is suitable

Staffan Holm 2011

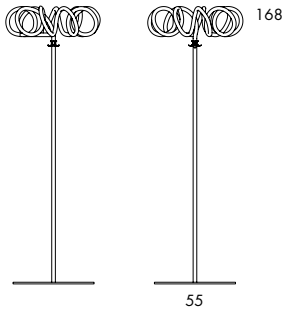
A30 | **VISP**

A30 16.8 kg | 0.25 m³/pc

COAT HANGER. Painted steel. Footplate diameter 49 cm.

A30 Black or white steel cc. 2a Fine textured finish	653
A30 Painted steel as per cc. 2b Smooth matte finish	784
A30 Painted steel in custom RAL colour*. Min. 8 pcs/colour	653

Surcharge, net (+)

*Set-up charge for custom RAL colour. NET/colour	650
--	------------

Stefan Borselius 2012

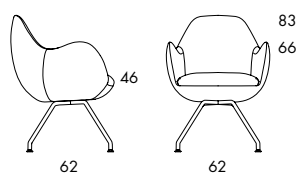
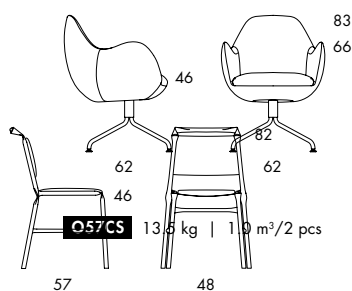
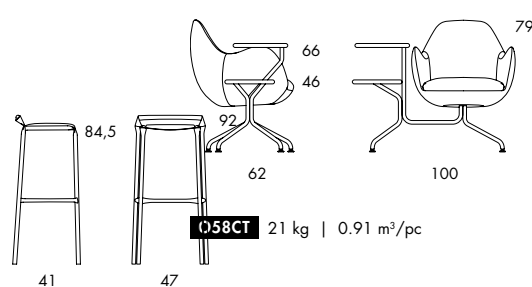
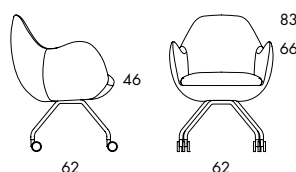
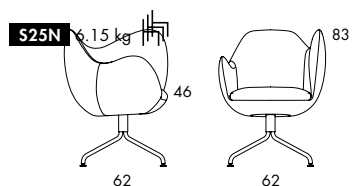
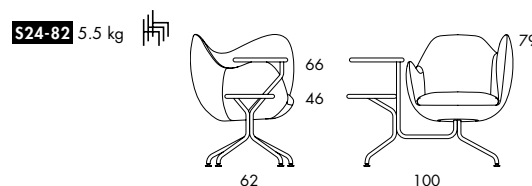
O55, O56, O57, O58, O59 | **WILMER****O59C** 12 kg | 0.91 m³/2 pcs**O57CS** 13.5 kg | 1.0 m³/2 pcs**O58CT** 21 kg | 0.91 m³/pc**O59CW** 12 kg | 0.91 m³/2 pcs**O55S** 14 kg | 1.0 m³/2 pcs**O56T** 21.5 kg | 0.91 m³/pc

MULTIFUNCTIONAL EASY CHAIR | CONFERENCE CHAIR. Wood and steel frame. Padding in CMHR moulded polyurethane foam. Upholstered in fabric or leather. Leather as per cc. óa. Chrome-plated (chrome III) or black-painted steel frame. Wilmer is available with symmetrical and asymmetrical armrests. Wilmer O58T and O56CT have tabletops of solid, painted wood. The top tabletop is reversible.

Fabric	Xtreme	Basic	1	2	3	4	Leather
O59C Chrome	1 499	1 578	1 624	1 685	1 750	1 817	2 213
O59CW Chrome Frame with casters	1 516	1 594	1 642	1 702	1 766	1 833	2 233
O59CW Black steel Frame with casters	1 492	1 561	1 611	1 674	1 742	1 810	2 191
O57CS Chrome Swivel base	1 738	1 785	1 864	1 925	1 991	2 060	2 456
O57CS Black steel Swivel base	1 788	1 836	1 917	1 977	2 042	2 110	2 510
O55S Chrome Swivel base	1 738	1 785	1 864	1 925	1 991	2 060	2 456
O55S Black steel Swivel base	1 788	1 836	1 917	1 977	2 042	2 110	2 510
O58CT Chrome Tabletops in clear-lacquered ash	2 189	2 258	2 308	2 370	2 438	2 505	2 902
O58CT Black steel Tabletops in clear-lacquered ash	2 241	2 310	2 360	2 422	2 489	2 556	2 955
O56T Chrome Tabletops in clear-lacquered ash	2 189	2 258	2 308	2 370	2 438	2 505	2 902
O56T Black steel Tabletops in clear-lacquered ash	2 241	2 310	2 360	2 422	2 489	2 556	2 955

Surcharge (+)

Tabletops in oiled or lacquered oak	16
Tabletops in black or white laminate	16



B30 15.7 kg | 0.9 m³/pc (1.7 m³/2 pcs)

B31 15.1 kg | 0.9 m³/pc (1.7 m³/2 pcs)

EASY CHAIR with armrests. Steel frame. Moulded CMHR polyurethane foam padding. Upholstered in fabric or leather. Leather as per cc. 6a. Frame in painted steel. B30 has table-top and B31 has no table-top. Table-top in lacquered or oiled oak or stone slab.

Fabric	Xtreme	Basic	1	2	3	4	Leather
B30 Black Clear lacquered or oiled oak	1 431	1 477	1 525	1 569	1 616	1 681	2 022
B30 Black Clear lacquered ash	1 431	1 477	1 525	1 569	1 616	1 681	2 022
B30 Black White Carrara marble	1 598	1 644	1 694	1 736	1 783	1 848	2 189
B30 Black Green Guatemala marble	1 598	1 644	1 694	1 736	1 783	1 848	2 189
B30 Black Black Marquina marble	1 598	1 644	1 694	1 736	1 783	1 848	2 189
B31 Black Without table	1 431	1 477	1 525	1 569	1 616	1 681	2 022

Surcharge, net (+)

Setup charge for frames in other colours as per cc. 2b. NET/colour	220
Setup charge for frame in custom RAL colour. NET/colour	650

Other finishes available for projects.

TABLETOPS

SOLID OAK & ASH

Thickness 25 or 30 mm.

Tabletop (cm)	Ø55	Ø70	Ø90	70x70	140x70
Clear-lacquered ash 25 mm	267	363	597	363	725
Clear-lacquered or oiled oak 25 mm	267	363	597	363	725
Black-stained oak 25 mm	302	431	677	431	830
Clear-lacquered ash 30 mm	303	416	683	416	823
Lacquered or oiled oak 30 mm	303	416	683	416	823
Black-stained oak 30 mm	338	486	761	486	931

COMPACT LAMINATE WHITE F2255

Standard F Collection. Rounded edge. Thickness 12 mm.

Tabletop (cm)	Ø60	Ø75	Ø90	Ø120	Ø140
White	322	366	444	819	1 161

Tabletop (cm)	50x50	70x70	140x70
White	222	355	598

COMPACT LAMINATE BLACK F2253 & GREY F7927

Standard F Collection. Rounded edge. Thickness 12 mm.

Tabletop (cm)	Ø60	Ø75	Ø90	50x50	70x70	140x70
Black or grey 1-4 pcs	442	475	575	350	464	706
Black or grey 5-9 pcs	370	422	513	256	423	688
Black or grey 10-20 pcs	353	403	489	245	391	659

Other materials, sizes and RAL colours available for contract projects.

Blå Station AB. Box 100
S-296 22 Åhus. Sweden
Tel: +46 (0)44 24 90 70
Fax: +46 (0)44 24 12 14

info@blastation.se
www.blastation.com

BLÅ STATION